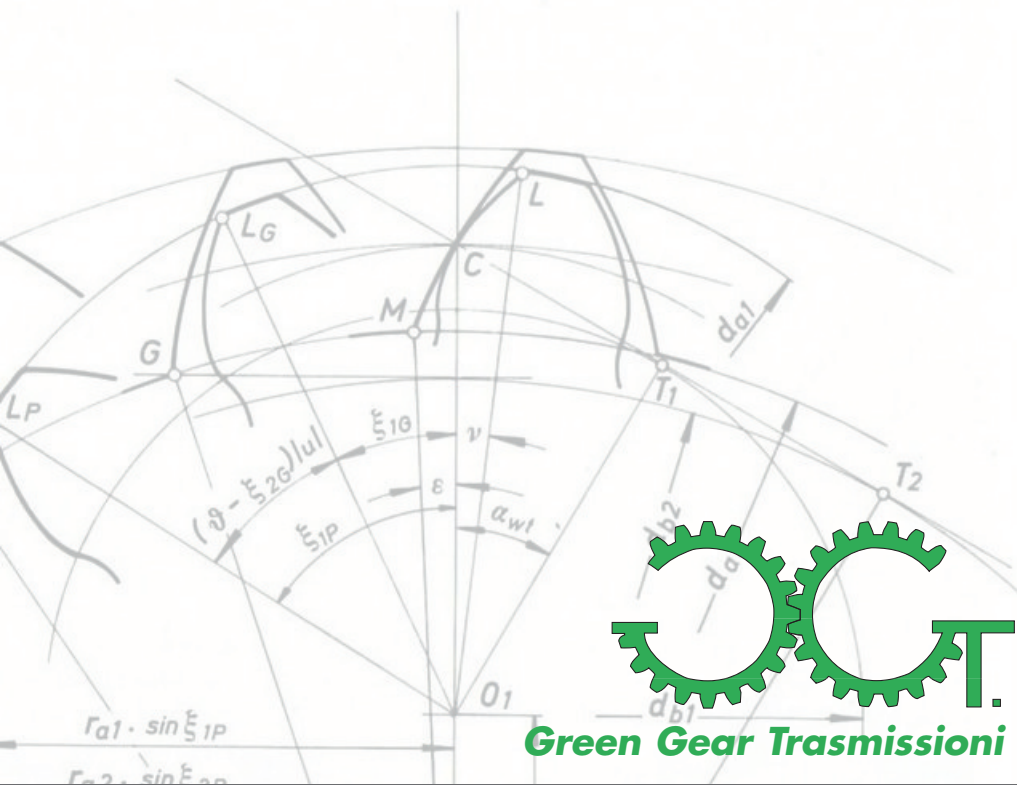
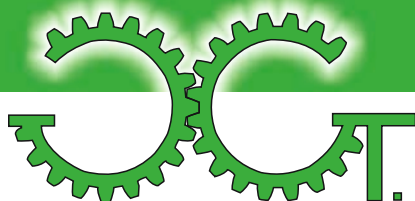


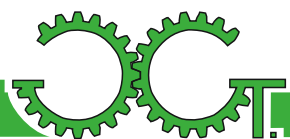
CATALOGO - GIUNTI A DENTI IN ACCIAIO

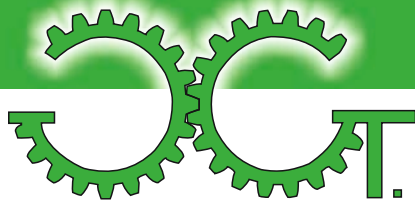




INDICE

Giunti a denti GGT	pag.1
Acciai e trattamenti	pag.1
Dimensionamento	pag.2
Fattore di servizio	pag.2
Disallineamento	pag.3
Dentatura GGT	pag.3
Giunti a denti standard – serie FGC	pag.4
Giunti a denti con un mozzo invertito – serie FGC.R	pag.5
Giunti a denti con mozzi invertiti – serie FGC.RR	pag.6
Giunti a denti con un mozzo prolungato – serie FGC.L	pag.7
Giunti a denti con mozzi prolungati – serie FGC.LL	pag.8
Giunti a denti con un mozzo rigido – serie RGC	pag.9
Giunti a denti – serie pesante FGC	pag.10
Giunti a denti con disco freno – serie FGC.BD	pag.11
Giunti a denti con disco freno Twiflex – serie FGC.DT	pag.12
Giunti a denti con fascia freno – serie FGC.BP	pag.13
Giunti a denti con spine di rottura – serie FGC.SD	pag.14
Giunti a denti a manicotto – serie FGC.CS	pag.15
Giunti a denti per motori mill – serie FGC.MM	pag.16
Giunti a denti scorrevoli – serie FGC.S	pag.17
Giunti a denti a doppio scorrimento – FGC.SS	pag.18
Giunti a denti disinnestabili – serie FGC.DI	pag.19
Giunti a denti con spaziatore tubolare – serie FGC.T	pag.20
Giunti a denti con spaziatore tubolare e un mozzo prolungato – serie FGC.TL	pag.21
Giunti a denti con spaziatore tubolare e mozzi prolungati – serie FGC.TLL	pag.21
Giunti a denti con spaziatore tubolare e un mozzo invertito – serie FGC.TR	pag.22
Giunti a denti con spaziatore tubolare e mozzi invertiti – serie FGC.TRR	pag.22
Giunti a denti con albero intermedio flottante – serie FGC.S	pag.23
Giunti a denti con albero intermedio flottante e mozzi invertiti – serie FGC.SR	pag.24
Giunti a denti per applicazioni verticali – serie FGC.V	pag.25
Giunti a denti con spaziatore tubolare per montaggio verticale – serie FGC.TV	pag.26
Giunti a denti in acciaio inossidabile – serie FGC.SS	pag.27
Giunti a denti con isolamento elettrico – serie FGC.EI	pag.28
Giunti a denti con guarnizioni in feltro – serie FGC.FE	pag.29
Giunti a denti AGMA – serie FGC.AGMA	pag.30
Tipologie di fori finiti	pag.32
Installazione, manutenzione e lubrificazione	pag.33





GIUNTI A DENTI GGT

COMPOSIZIONE

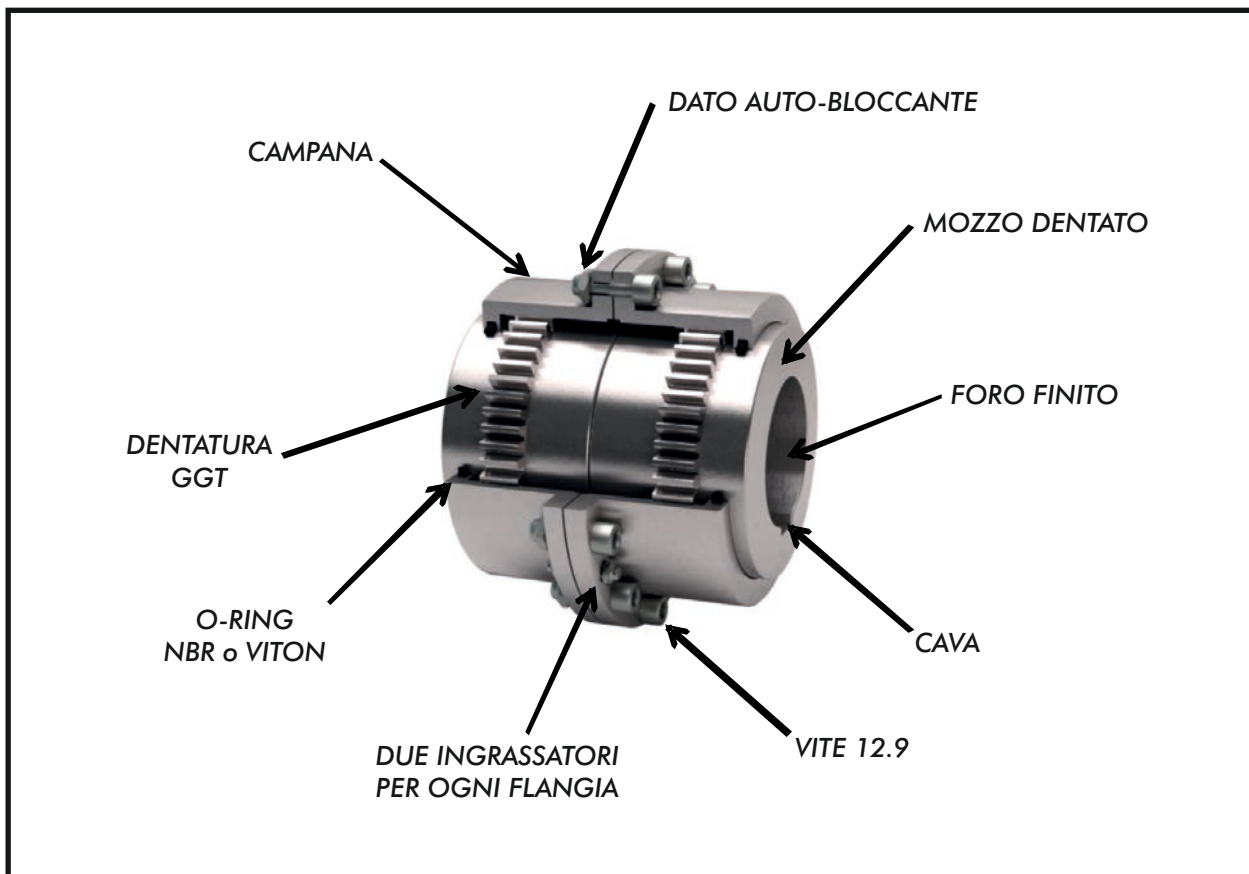


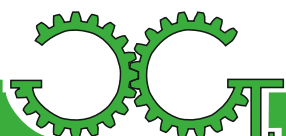
Fig.1

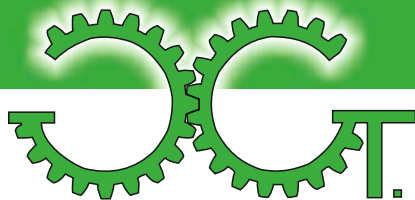


Fig.2

ACCIAI E TRATTAMENTI

I giunti GGT (Green Gear Trasmissioni S.r.l.) della serie FGC sono costruiti e disponibili in acciaio bonificato AISI1045, AISI4140 oppure in acciaio inossidabile AISI630. Bulloni in classe 12.9, tappi ingrassatori in acciaio inox e guarnizioni o-ring in gomma NBR o in Viton.





DIMENSIONAMENTO

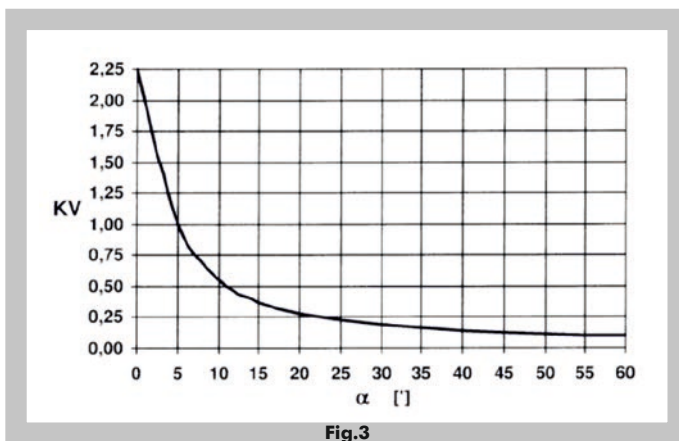
a) Calcolare la coppia da trasmettere, considerando il fattore di servizio **SF** (fig.4) ed il fattore di coppia **KD**, applicando la formula a fianco;

$$T = \frac{P \times 9,55}{n} \times SF \times KD \quad [\text{kNm}]$$

b) Confermare la selezione controllando i diametri degli alberi di accoppiamento ai mozzi;

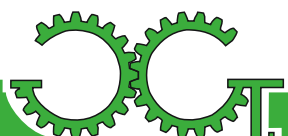
P = potenza assorbita [kW]
N = velocità [rpm]
T = coppia dell'applicazione [kNm]

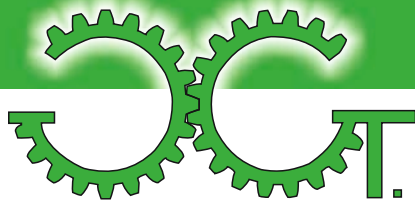
c) Controllare che la velocità massima **n** sia uguale o inferiore alla velocità massima del giunto selezionato moltiplicato per il fattore di velocità **KV**, che dipende dal disallineamento dell'applicazione α , come mostrato nella figura 3;



FATTORE DI SERVIZIO "SF"			
		Compressori alternativi	2
		Laminatoi a freddo	
		Calandre	
Agitatori per liquidi puri	1,5	Carriponti - gru	2,5
Generatori elettrici		Bobinatrici	
Ventilatori		Presse	
Pompe centrifughe		Maschiatrici	
Trasportatori a nastro	1,75	Frantoi	3
Pompe a capsulismo		Calandre per gomma	
Pompe a doppio effetto		Mescolatoi per gomma	
Pompe a ingranaggi		Tavole a rulli	
Trasportatori a tazze		Laminatoi a caldo	
Trasportatori a catena		Comando vitoni	
Trasportatori a vite	Aspi	Laminatoi a freddo revers.	
Compressori centrifughi			

Fig.4





DISASSAMENTO E DISALLINEAMENTO

Il principio di funzionamento dei giunti a denti, illustrato sinteticamente nella figura 1, si basa sull'ingranamento della dentatura esterna del mozzo con la dentatura interna del manicotto, o campana, che consente la trasmissione della coppia tra le flange. Il relativo disassamento viene compensato dallo scorrimento assiale della dentatura interna sulla dentatura esterna.

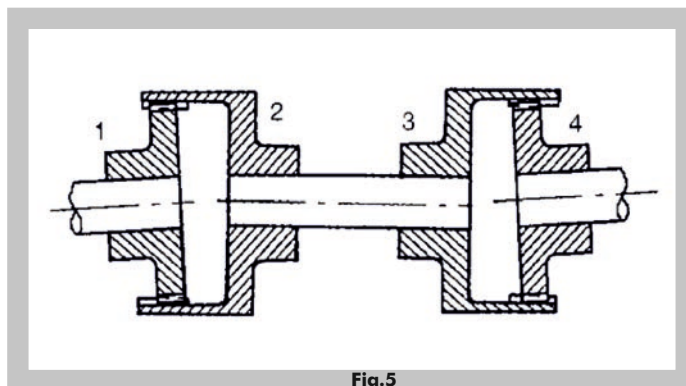


Fig.5

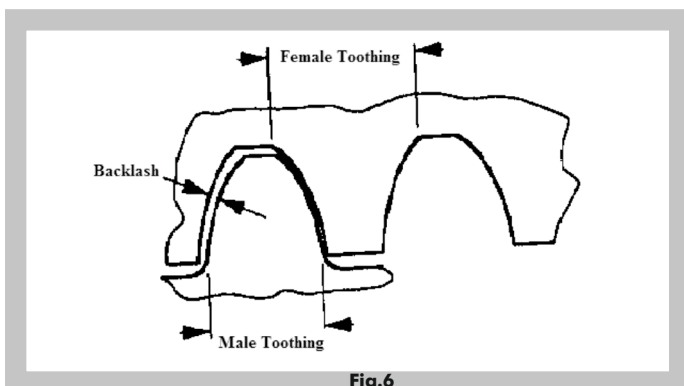


Fig.6

Mediante la dentatura bombata, i nostri giunti assicurano collegamenti ottimali e torsionalmente rigidi, tra i più diversi dispositivi, anche con moderati disallineamenti, spostamenti assiali e radiali.

Massimo disallineamento permesso dai giunti GGT:

- Serie Standard: $0^{\circ}10'$
- Con trattamento termico: $0^{\circ}15'$

DENTATURA GGT

La dentatura bombata dei giunti a denti GGT, serie FGC, è stata progettata per assicurare condizioni di disallineamento su più estese superfici di contatto. Lo scostamento del profilo utilizzato determina l'aumento dello spessore del dente e quindi la resistenza della dentatura stessa.

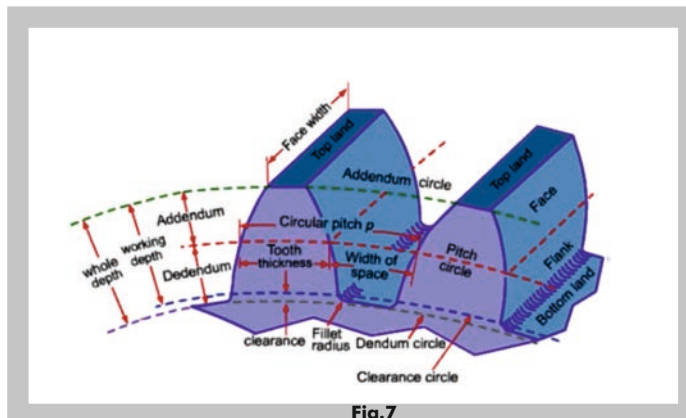
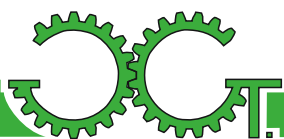
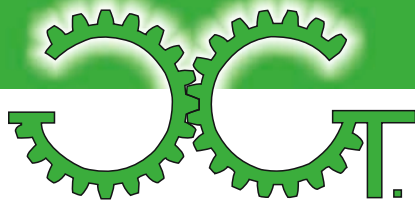


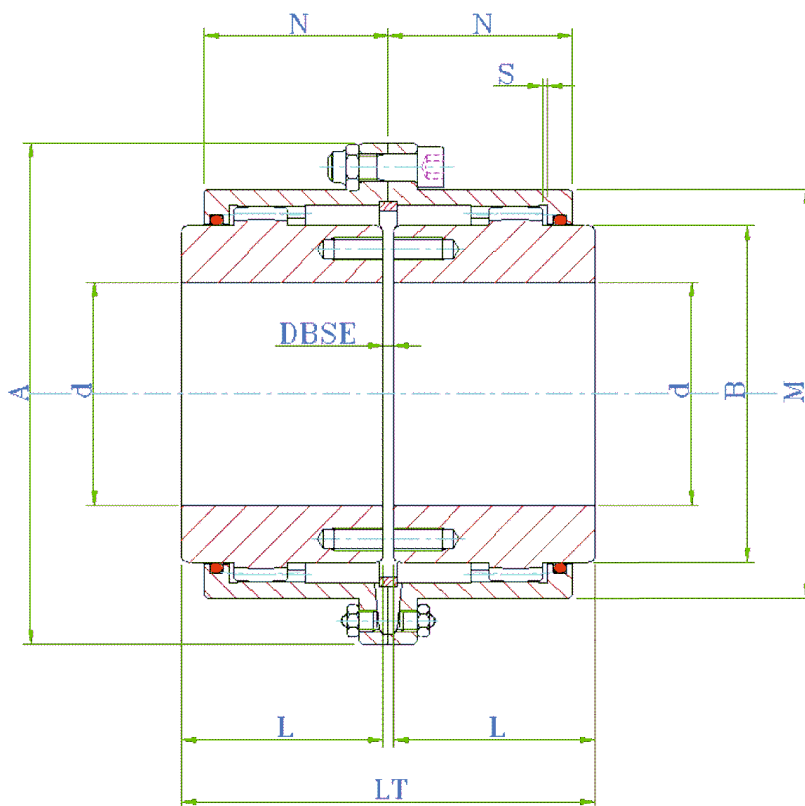
Fig.7





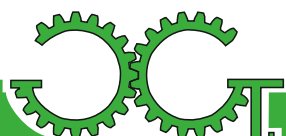
GIUNTI A DENTI STANDARD

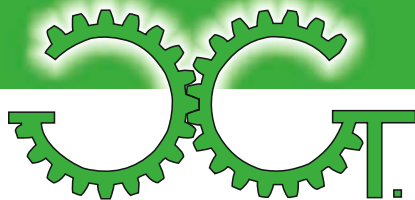
SERIE FGC



TAGLIA	Tk [kNm]	Tmax [kNm]	VELOCITA' MAX [rpm]	FORO MAX d [mm]	A [mm]	B [mm]	L [mm]	LT [mm]	M [mm]	N [mm]	DBSE [mm]	PESO [kg]
FGC.96	1.9	4.2	6000	52	111	68	43	89	82.5	39	3	4.2
FGC.122	2.9	6.8	4550	62	142	86	50	103	104.6	45.5	3	7.6
FGC.148	5.7	14.0	4000	78	168	105	62	127	130.5	59	3	13.5
FGC.178	9.0	21.5	3900	98	200	132	76	157	158.4	68	5	25
FGC.203	14.5	35.0	3700	112	225	151	90	185	183.4	82.5	5	37
FGC.236	22.8	54.7	3550	132	265	179	105	216	211.5	93	6	60
FGC.270	34.8	83.5	3000	156	300	209	120	246	245.5	106	6	90
FGC.300	45.8	110	2750	174	330	234	135	278	275	118	8	124
FGC.335	70.8	170	2420	190	370	255	150	308	307	138	8	170
FGC.368	85.4	205	2270	210	406	280	175	358	335	154	8	233
FGC.400	150	360	1950	233	439	306	190	388	367	166	8	298
FGC.460	200	480	1730	280	505	356	220	450	423	193	10	457

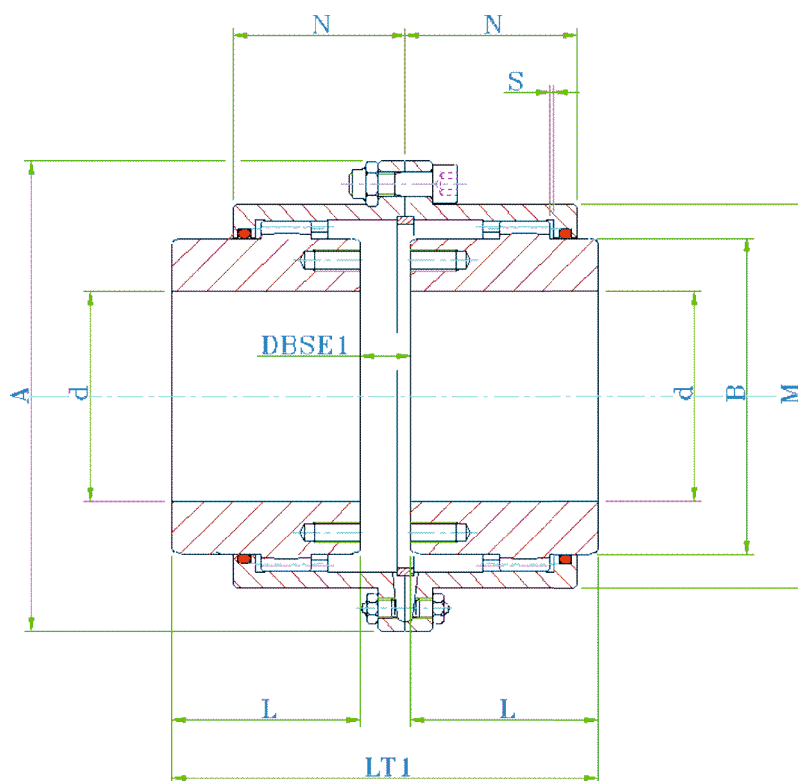
S = DBSE/2





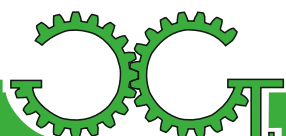
GIUNTI A DENTI CON UN MOZZO INVERTITO

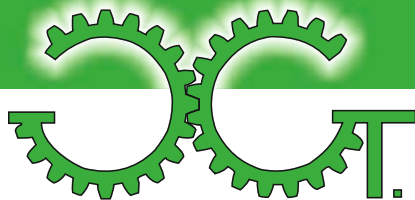
SERIE FGC.R



TAGLIA	Tk [kNm]	Tmax [kNm]	VELOCITA' MAX [rpm]	FORO MAX d [mm]	A [mm]	B [mm]	L [mm]	LT1 [mm]	M [mm]	N [mm]	DBSE1 [mm]	PESO [kg]
FGC.96.R	1.9	4.2	6000	52	111	68	43	91	82.5	39	5	4.2
FGC.122.R	2.9	6.8	4550	62	142	86	50	108	104.6	45.5	8	7.6
FGC.148.R	5.7	14.0	4000	78	168	105	62	138	130.5	59	14	13.5
FGC.178.R	9.0	21.5	3900	98	200	132	76	170	158.4	68	18	25
FGC.203.R	14.5	35.0	3700	112	225	151	90	204	183.4	82.5	24	37
FGC.236.R	22.8	54.7	3550	132	265	179	105	237	211.5	93	27	60
FGC.270.R	34.8	83.5	3000	156	300	209	120	272	245.5	106	32	90
FGC.300.R	45.8	110	2750	174	330	234	135	307	275	118	37	124
FGC.335.R	70.8	170	2420	190	370	255	150	350	307	138	50	170
FGC.368.R	85.4	205	2270	210	406	280	175	403	335	154	53	233
FGC.400.R	150	360	1950	233	439	306	190	438	367	166	58	298
FGC.460.R	200	480	1730	280	505	356	220	512	423	193	72	457

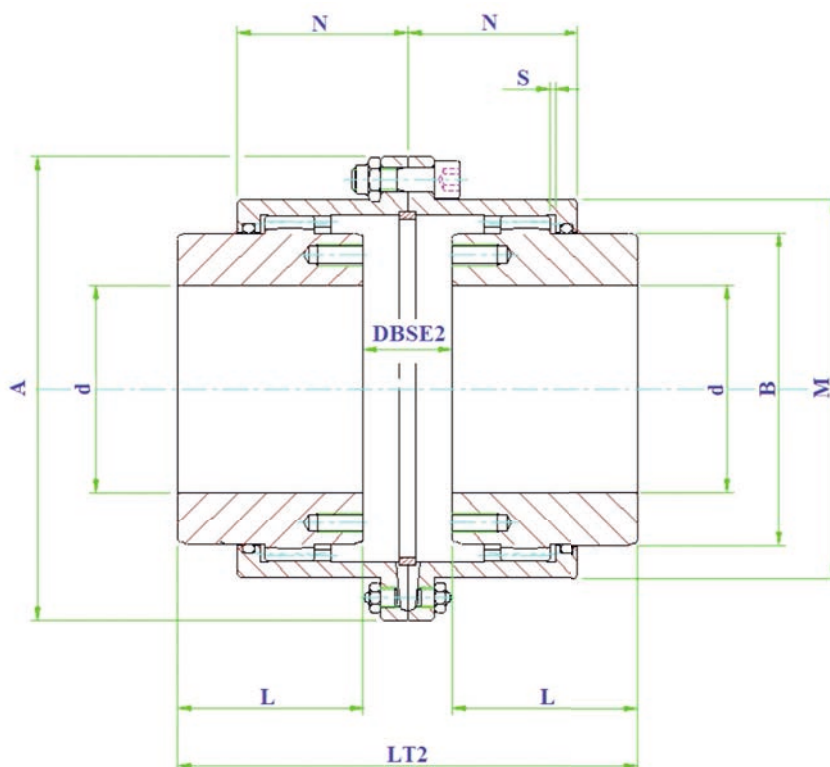
S = DBSE1/2





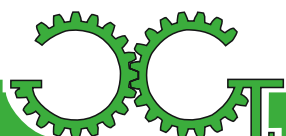
GIUNTI A DENTI CON MOZZI INVERTITI

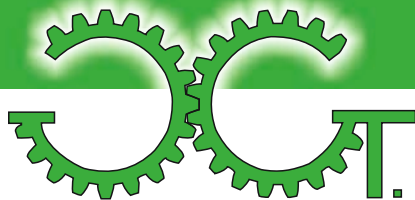
SERIE FGC.RR



TAGLIA	Tk [kNm]	Tmax [kNm]	VELOCITA' MAX [rpm]	FORO MAX d [mm]	A [mm]	B [mm]	L [mm]	LT2 [mm]	M [mm]	N [mm]	DBSE2 [mm]	PESO [kg]
FGC.96.RR	1.9	4.2	6000	52	111	68	43	93	82.5	39	7	4.2
FGC.122.RR	2.9	6.8	4550	62	142	86	50	113	104.6	45.5	13	7.6
FGC.148.RR	5.7	14.0	4000	78	168	105	62	149	130.5	59	25	13.5
FGC.178.RR	9.0	21.5	3900	98	200	132	76	184	158.4	68	32	25
FGC.203.RR	14.5	35.0	3700	112	225	151	90	223	183.4	82.5	43	37
FGC.236.RR	22.8	54.7	3550	132	265	179	105	258	211.5	93	48	60
FGC.270.RR	34.8	83.5	3000	156	300	209	120	298	245.5	106	58	90
FGC.300.RR	45.8	110	2750	174	330	234	135	336	275	118	66	124
FGC.335.RR	70.8	170	2420	190	370	255	150	392	307	138	92	170
FGC.368.RR	85.4	205	2270	210	406	280	175	448	335	154	98	233
FGC.400.RR	150	360	1950	233	439	306	190	488	367	166	108	298
FGC.460.RR	200	480	1730	280	505	356	220	574	423	193	134	457

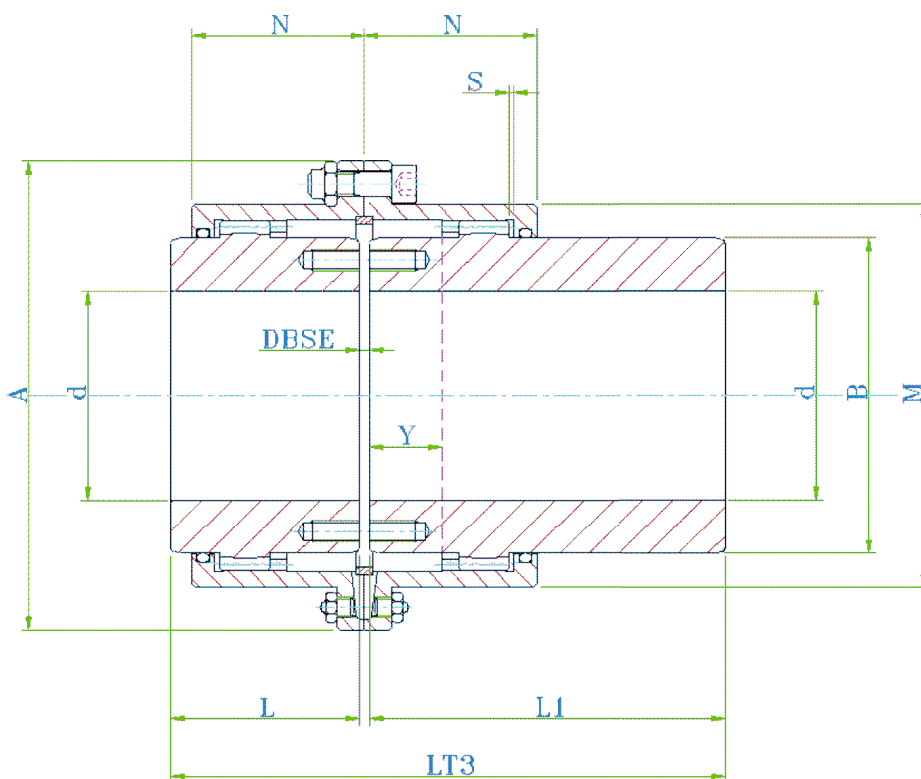
S = DBSE/2





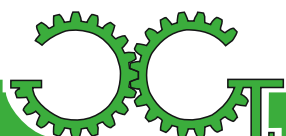
GIUNTI A DENTI CON UN MOZZO PROLUNGATO

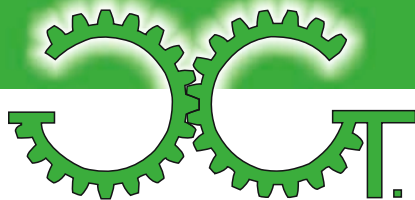
SERIE FGC.L



TAGLIA	Tk [kNm]	Tmax [kNm]	VELOCITA' MAX [rpm]	FORO MAX d [mm]	A [mm]	B [mm]	L1 [mm]	LT3 [mm]	M [mm]	N [mm]	Y [mm]	DBSE [mm]	PESO [kg]
FGC.96.L	1.9	4.2	6000	52	111	68	105	151	82.5	39	12	3	6.15
FGC.122.L	2.9	6.8	4550	62	142	86	115	168	104.6	45.5	16	3	10.2
FGC.148.L	5.7	14.0	4000	78	168	105	130	195	130.5	59	22	3	18.2
FGC.178.L	9.0	21.5	3900	98	200	132	150	231	158.4	68	26	5	33
FGC.203.L	14.5	35.0	3700	112	225	151	170	265	183.4	82.5	38	5	48.5
FGC.236.L	22.8	54.7	3550	132	265	179	185	296	211.5	93	45	6	56.5
FGC.270.L	34.8	83.5	3000	156	300	209	215	296	245.5	106	50	6	115
FGC.300.L	45.8	110	2750	174	330	234	245	341	275	118	58	8	161
FGC.335.L	70.8	170	2420	190	370	255	295	388	307	138	70	8	227
FGC.368.L	85.4	205	2270	210	406	280	300	453	335	154	80	8	292
FGC.400.L	150	360	1950	233	439	306	305	483	367	166	86	8	363
FGC.460.L	200	480	1730	280	505	356	310	540	423	193	96	10	526

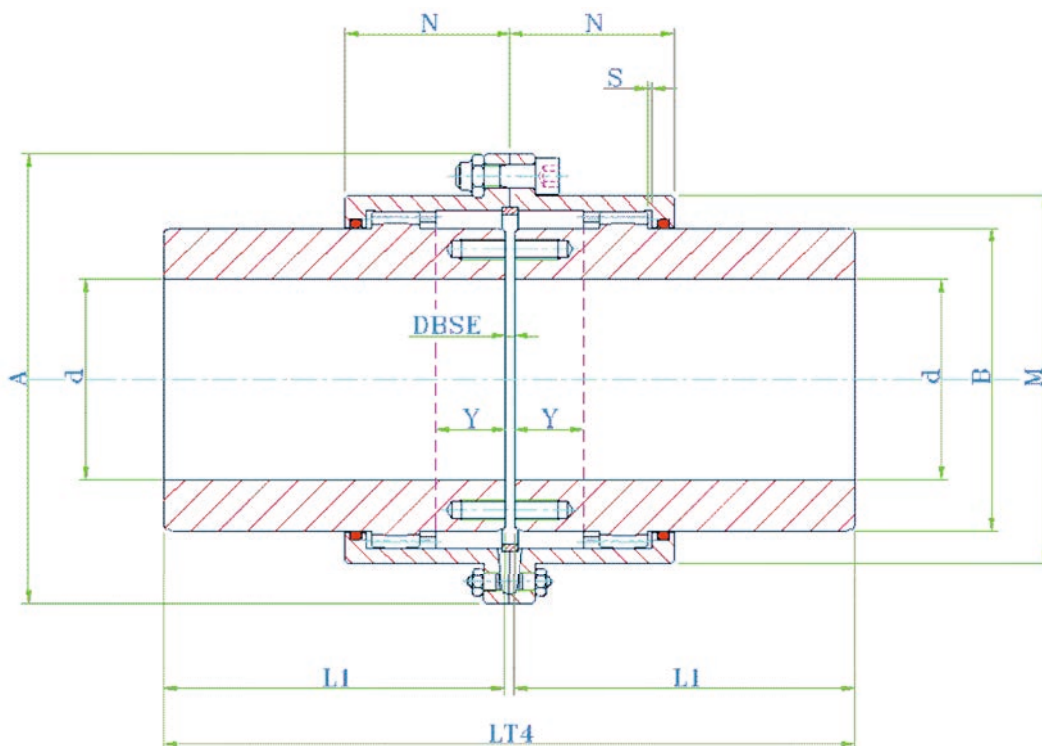
S = DBSE/2





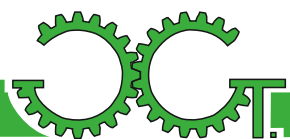
GIUNTI A DENTI CON MOZZI PROLUNGATI

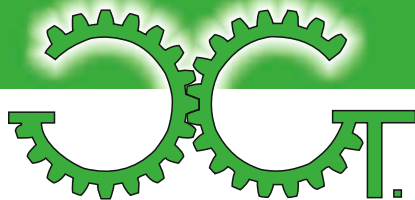
SERIE FGC.LL



TAGLIA	Tk [kNm]	Tmax [kNm]	VELOCITA' MAX [rpm]	FORO MAX d [mm]	A [mm]	B [mm]	L1 [mm]	LT4 [mm]	M [mm]	N [mm]	Y [mm]	DBSE [mm]	PESO [kg]
FGC.96.LL	1.9	4.2	6000	52	111	68	105	213	82.5	39	12	3	8
FGC.122.LL	2.9	6.8	4550	62	142	86	115	233	104.6	45.5	16	3	13
FGC.148.LL	5.7	14.0	4000	78	168	105	130	263	130.5	59	22	3	23
FGC.178.LL	9.0	21.5	3900	98	200	132	150	305	158.4	68	26	5	41
FGC.203.LL	14.5	35.0	3700	112	225	151	170	345	183.4	82.5	38	5	60
FGC.236.LL	22.8	54.7	3550	132	265	179	185	376	211.5	93	45	6	91
FGC.270.LL	34.8	83.5	3000	156	300	209	215	436	245.5	106	50	6	141
FGC.300.LL	45.8	110	2750	174	330	234	245	498	275	118	58	8	199
FGC.335.LL	70.8	170	2420	190	370	255	295	598	307	138	70	8	285
FGC.368.LL	85.4	205	2270	210	406	280	300	608	335	154	80	8	352
FGC.400.LL	150	360	1950	233	439	306	305	618	367	166	86	8	428
FGC.460.LL	200	480	1730	280	505	356	310	630	423	193	96	10	596

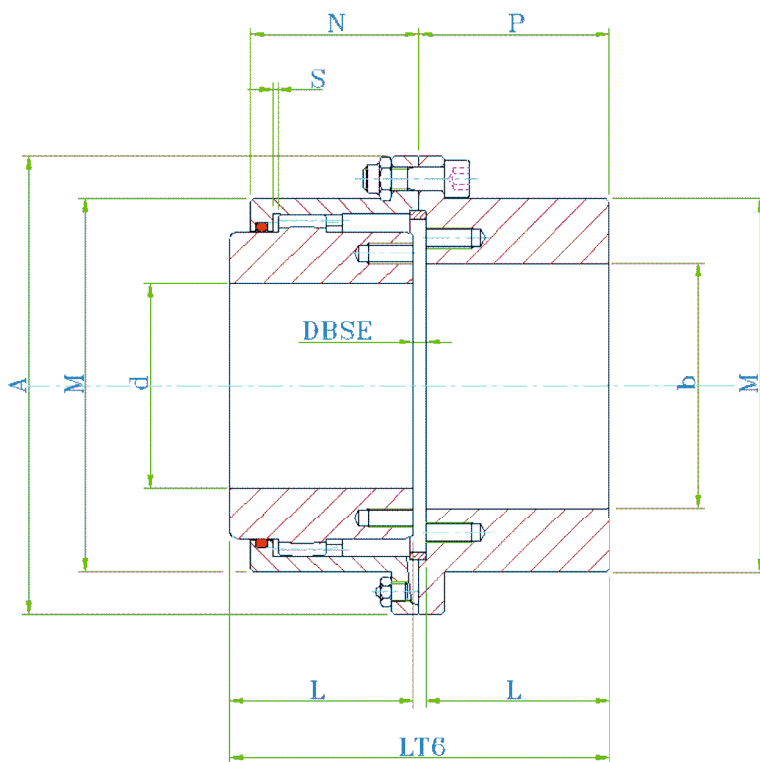
S = DBSE/2





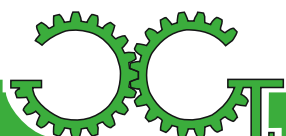
GIUNTI A DENTI CON UN MOZZO RIGIDO

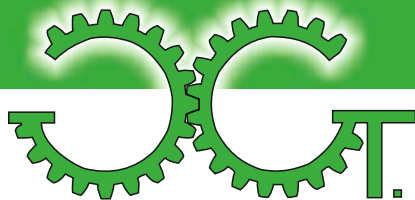
SERIE RGC



TAGLIA	Tk [kNm]	Tmax [kNm]	VELOCITA' MAX [rpm]	FORO MAX d [mm]	FORO MAX b [mm]	A [mm]	L [mm]	LT6 [mm]	M [mm]	N [mm]	P [mm]	DBSE [mm]	PESO [kg]
RGC.96	1.9	4.2	6000	52	60	111	43	89	82.5	39	44.5	3	4.5
RGC.122	2.9	6.8	4550	62	75	142	50	103	104.6	45.5	51.5	3	8
RGC.148	5.7	14.0	4000	78	90	168	62	127	130.5	59	63.5	3	14
RGC.178	9.0	21.5	3900	98	110	200	76	157	158.4	68	78.5	5	26
RGC.203	14.5	35.0	3700	112	130	225	90	185	183.4	82.5	92.5	5	39
RGC.236	22.8	54.7	3550	132	150	265	105	216	211.5	93	108	6	63
RGC.270	34.8	83.5	3000	156	175	300	120	246	245.5	106	123	6	95
RGC.300	45.8	110	2750	174	195	330	135	278	275	118	139	8	131
RGC.335	70.8	170	2420	190	220	370	150	308	307	138	154	8	180
RGC.368	85.4	205	2270	210	240	406	175	358	335	154	179	8	248
RGC.400	150	360	1950	233	260	439	190	388	367	166	194	8	318
RGC.460	200	480	1730	280	300	505	220	450	423	193	225	10	488

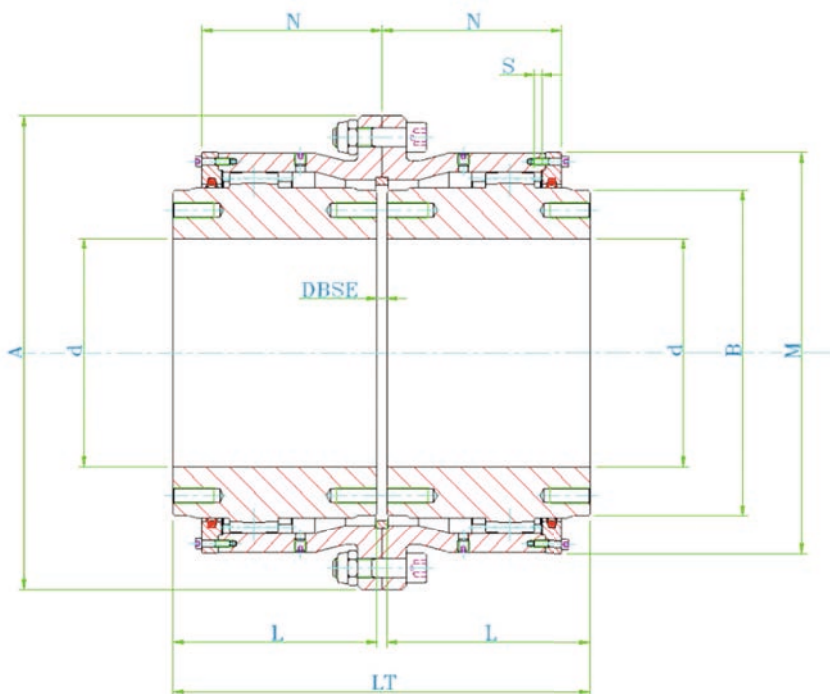
S = DBSE/2



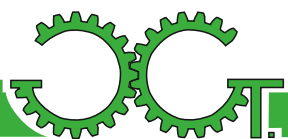


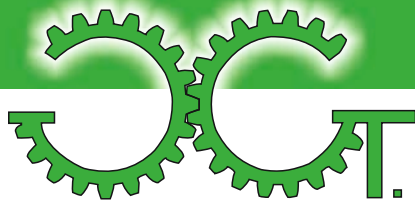
GIUNTI A DENTI SERIE PESANTE

SERIE FGC



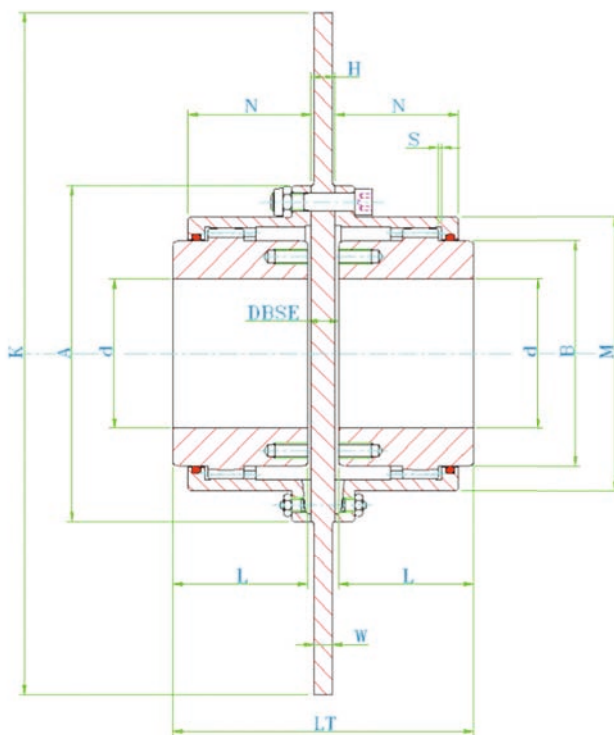
TAGLIA	Tk [kNm]	Tmax [kNm]	VELOCITA' MAX [rpm]	FORO MAX d [mm]	A [mm]	B [mm]	L [mm]	LT [mm]	M [mm]	N [mm]	DBSE [mm]	PESO [kg]
FGC.531	290	580	1100	325	590	410	260	532	503	221	12	722
FGC.581	402	804	990	370	639	460	290	592	553	245	12	972
FGC.636	518	1036	890	400	710	500	320	652	597	262	12	1292
FGC.696	693	1386	785	430	769	560	350	712	657	280	12	1695
FGC.762	882	1764	700	475	834	620	380	772	722	292	12	2215
FGC.812	1040	2080	645	510	894	660	400	820	763	315	20	2695
FGC.862	1255	2510	600	530	944	690	420	860	813	327	20	3150
FGC.937	1633	3266	540	580	1020	760	440	900	888	346	20	3950
FGC.997	1906	3812	500	610	1095	800	480	990	938	385	30	4915
FGC.1097	2636	5272	440	680	1195	880	530	1090	1038	414	30	6566
FGC.1242	3707	7414	380	780	1350	1010	580	1190	1173	460	30	9420
FGC.1342	4662	9324	330	860	1450	1110	630	1300	1273	507	40	12390
FGC.1477	6216	12432	300	950	1584	1230	690	1420	1408	568	40	15904
FGC.1587	7539	15078	280	1020	1715	1320	730	1500	1508	602	40	19631
FGC.1687	8925	17850	250	1090	1815	1410	790	1620	1608	635	40	23543
FGC.1817	11130	22260	230	1180	1944	1530	840	1730	1738	680	50	29572



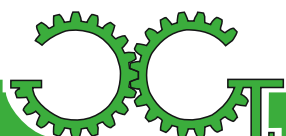


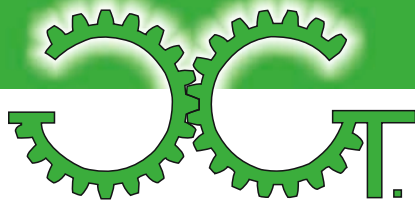
GIUNTI A DENTI CON DISCO FRENO

SERIE FGC.BD



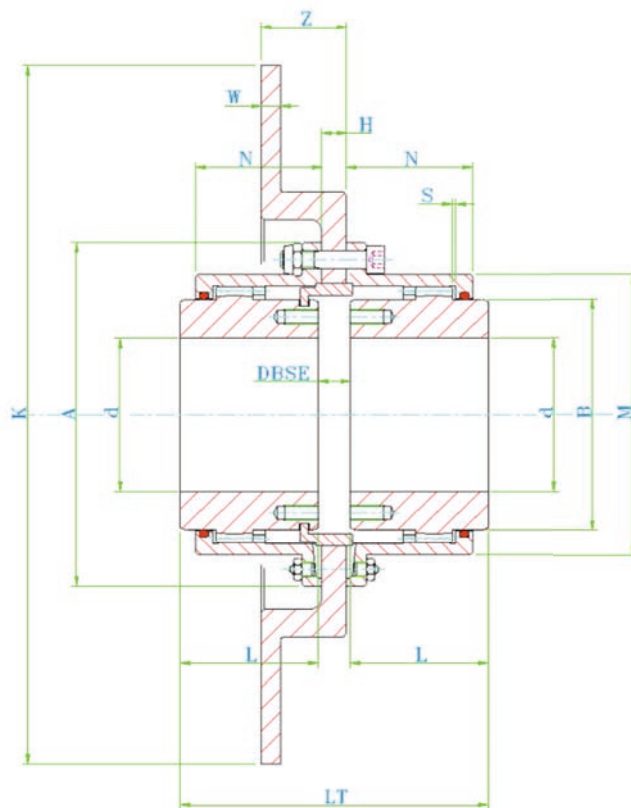
TAGLIA	Tk [kNm]	Tmax [kNm]	VELOCITA' MAX' [rpm]	FORO MAX d [mm]	A [mm]	B [mm]	L [mm]	LT [mm]	M [mm]	N [mm]	DBSE [mm]	K x H [mm]	W [mm]
FGC.96.BD	1.9	4.2	6000	52	111	68	43	89	82.5	39	3 + H	250x6	12.7
FGC.122.BD	2.9	6.8	4550	62	142	86	50	103	104.6	45.5	3 + H	300x13	12.7
FGC.148.BD	5.7	14.0	4000	78	168	105	62	127	130.5	59	3 + H	350x16	12.7
FGC.178.BD	9.0	21.5	3900	98	200	132	76	157	158.4	68	5 + H	400x13	12.7
FGC.203.BD	14.5	35.0	3700	112	225	151	90	185	183.4	82.5	5 + H	460x16	12.7
FGC.236.BD	22.8	54.7	3550	132	265	179	105	216	211.5	93	6 + H	515x16	12.7
FGC.270.BD	34.8	83.5	3000	156	300	209	120	246	245.5	106	6 + H	515x16	12.7
FGC.300.BD	45.8	110	2750	174	330	234	135	278	275	118	8 + H	610x16	12.7
FGC.335.BD	70.8	170	2420	190	370	255	150	308	307	138	8 + H	710x19	12.7
FGC.368.BD	85.4	205	2270	210	406	280	175	358	335	154	8 + H	810x25	12.7
FGC.400.BD	150	360	1950	233	439	306	190	388	367	166	8 + H	810x25	12.7
FGC.460.BD	200	480	1730	280	505	356	220	450	423	193	10 + H	915x25	12.7



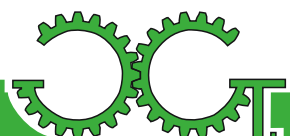


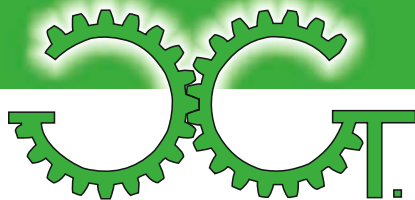
GIUNTI A DENTI CON DISCO FRENO TWIFLEX

SERIE FGC.DT



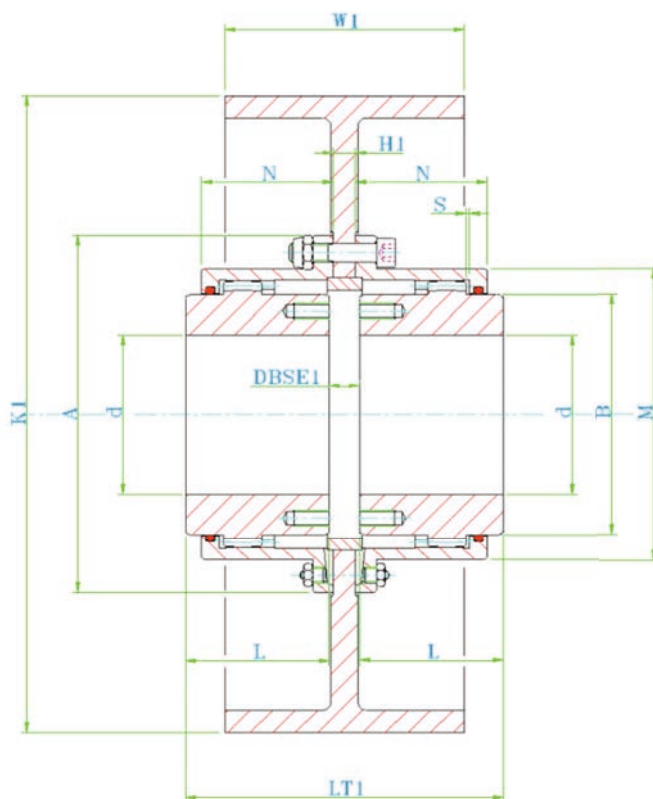
TAGLIA	Tk [kNm]	Tmax [kNm]	VELOCITA' MAX [rpm]	FORO MAX d [mm]	A [mm]	B [mm]	L [mm]	LT [mm]	M [mm]	N [mm]	DBSE [mm]	K x H [mm]	W [mm]
FGC.96.DT	1.9	4.2	6000	52	111	68	43	95	82.5	39	3 + H	250x6	12.7
FGC.122.DT	2.9	6.8	4550	62	142	86	50	116	104.6	45.5	3 + H	300x13	12.7
FGC.148.DT	5.7	14.0	4000	78	168	105	62	143	130.5	59	3 + H	350x16	12.7
FGC.178.DT	9.0	21.5	3900	98	200	132	76	170	158.4	68	5 + H	400x13	12.7
FGC.203.DT	14.5	35.0	3700	112	225	151	90	201	183.4	82.5	5 + H	460x16	12.7
FGC.236.DT	22.8	54.7	3550	132	265	179	105	216	211.5	93	6 + H	515x16	12.7
FGC.270.DT	34.8	83.5	3000	156	300	209	120	262	245.5	106	6 + H	515x16	12.7
FGC.300.DT	45.8	110	2750	174	330	234	135	294	275	118	8 + H	610x16	12.7
FGC.335.DT	70.8	170	2420	190	370	255	150	327	307	138	8 + H	710x19	12.7
FGC.368.DT	85.4	205	2270	210	406	280	175	383	335	154	8 + H	810x25	12.7
FGC.400.DT	150	360	1950	233	439	306	190	403	367	166	8 + H	810x25	12.7
FGC.460.DT	200	480	1730	280	505	356	220	475	423	193	10 + H	915x25	12.7



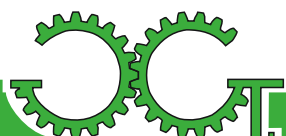


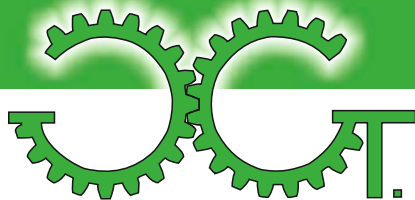
GIUNTI A DENTI CON FASCIA FRENO

SERIE FGC.BP



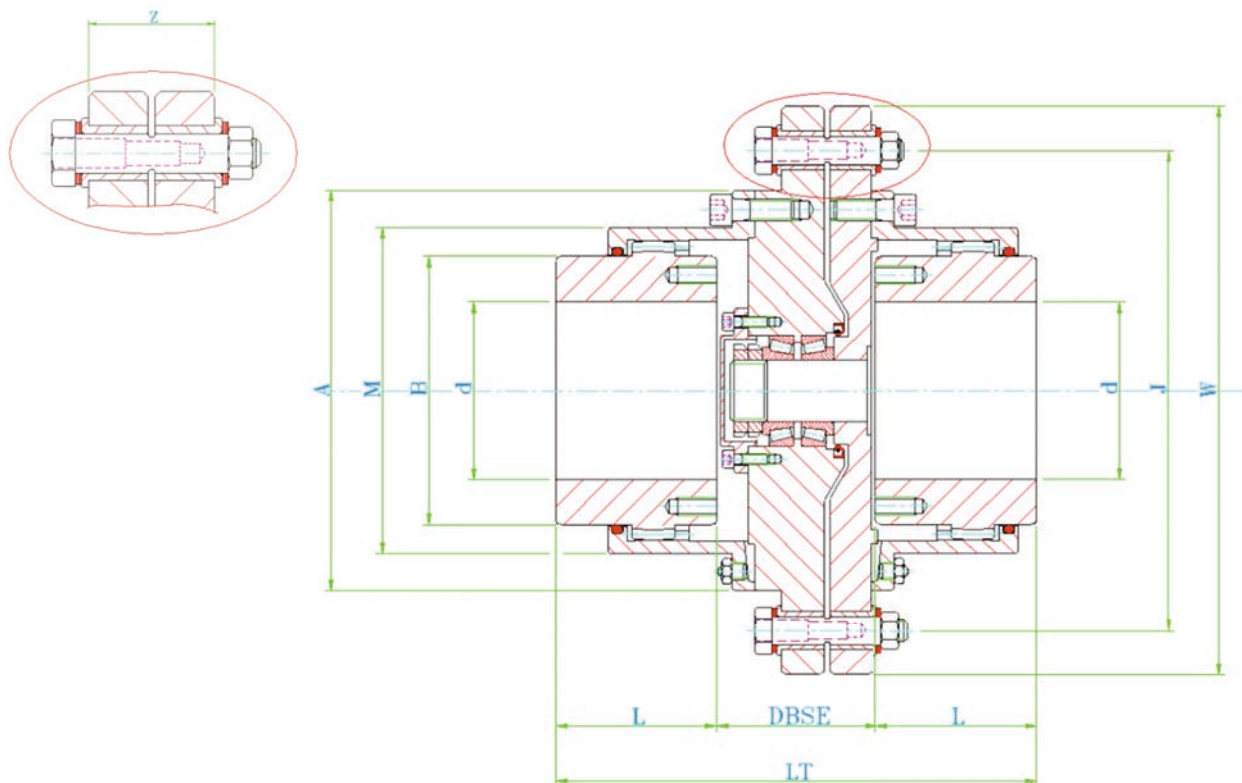
TAGLIA	Tk [kNm]	Tmax [kNm]	VELOCITA' MAX [rpm]	FORO MAX d [mm]	A [mm]	B [mm]	L [mm]	LT1 [mm]	M [mm]	N [mm]	DBSE1 [mm]	H1 [mm]	K1xW1 [mm]
FGC.96.BP	1.9	4.2	6000	52	111	68	43	95	82.5	39	3 + H1	8	200x75
FGC.122.BP	2.9	6.8	4550	62	142	86	50	116	104.6	45.5	3 + H1	8	200x75
FGC.148.BP	5.7	14.0	4000	78	168	105	62	143	130.5	59	3 + H1	10	250x95
FGC.178.BP	9.0	21.5	3900	98	200	132	76	170	158.4	68	5 + H1	10	250x95
FGC.203.BP	14.5	35.0	3700	112	225	151	90	201	183.4	82.5	5 + H1	12	315x118
FGC.236.BP	22.8	54.7	3550	132	265	179	105	216	211.5	93	6 + H1	14	400x150
FGC.270.BP	34.8	83.5	3000	156	300	209	120	262	245.5	106	6 + H1	18	500x190
FGC.300.BP	45.8	110	2750	174	330	234	135	294	275	118	8 + H1	18	500x190
FGC.335.BP	70.8	170	2420	190	370	255	150	327	307	138	8 + H1	22	630x236
FGC.368.BP	85.4	205	2270	210	406	280	175	383	335	154	8 + H1	22	630x236
FGC.400.BP	150	360	1950	233	439	306	190	403	367	166	8 + H1	22	630x236
FGC.460.BP	200	480	1730	280	505	356	220	475	423	193	10 + H1	22	710x265





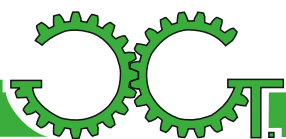
GIUNTI A DENTI CON SPINE DI ROTTURA

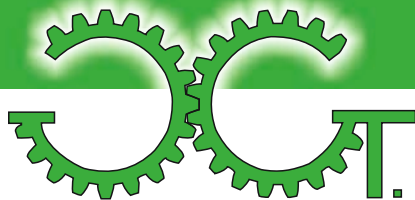
SERIE FGC.SD



TAGLIA	Tk [kNm]	Tmax [kNm]	VELOCITA' MAX [rpm]	FORO MAX d [mm]	A [mm]	B [mm]	L [mm]	N [mm]
FGC.96.SD	1.9	4.2	6000	52	111	68	43	39
FGC.122.SD	2.9	6.8	4550	62	142	86	50	45.5
FGC.148.SD	5.7	14.0	4000	78	168	105	62	59
FGC.178.SD	9.0	21.5	3900	98	200	132	76	68
FGC.203.SD	14.5	35.0	3700	112	225	151	90	82.5
FGC.236.SD	22.8	54.7	3550	132	265	179	105	93
FGC.270.SD	34.8	83.5	3000	156	300	209	120	106
FGC.300.SD	45.8	110	2750	174	330	234	135	118
FGC.335.SD	70.8	170	2420	190	370	255	150	138
FGC.368.SD	85.4	205	2270	210	406	280	175	154
FGC.400.SD	150	360	1950	233	439	306	190	166
FGC.460.SD	200	480	1730	280	505	356	220	193

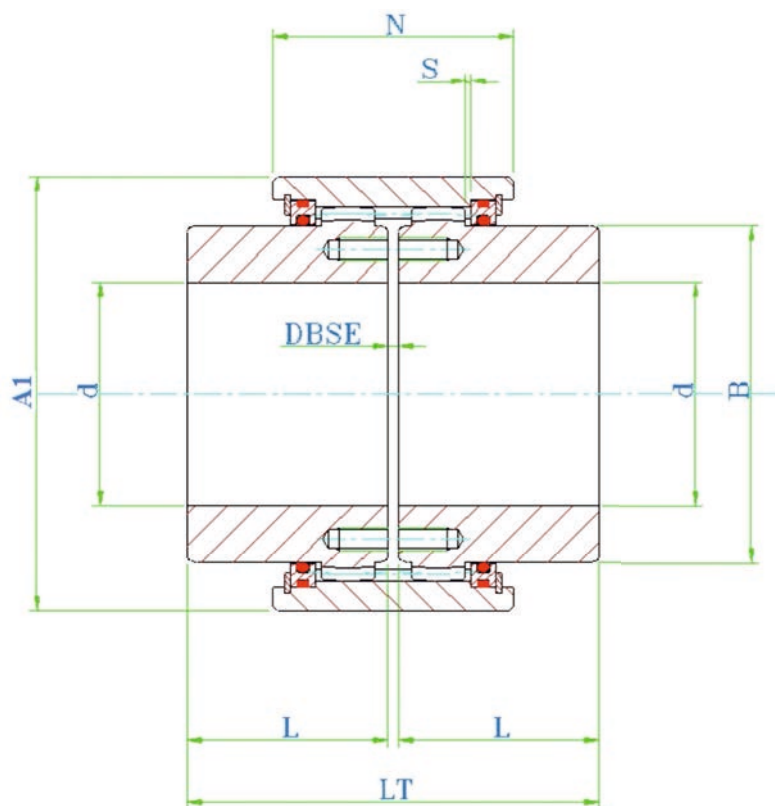
Dimensioni: W,J,Z,DBSE su misura



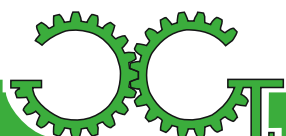


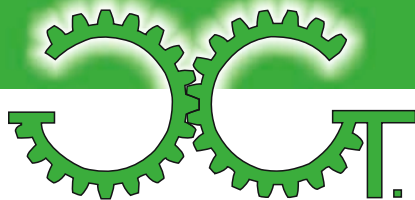
GIUNTI A DENTI A MANICOTTO

SERIE FGC.CS



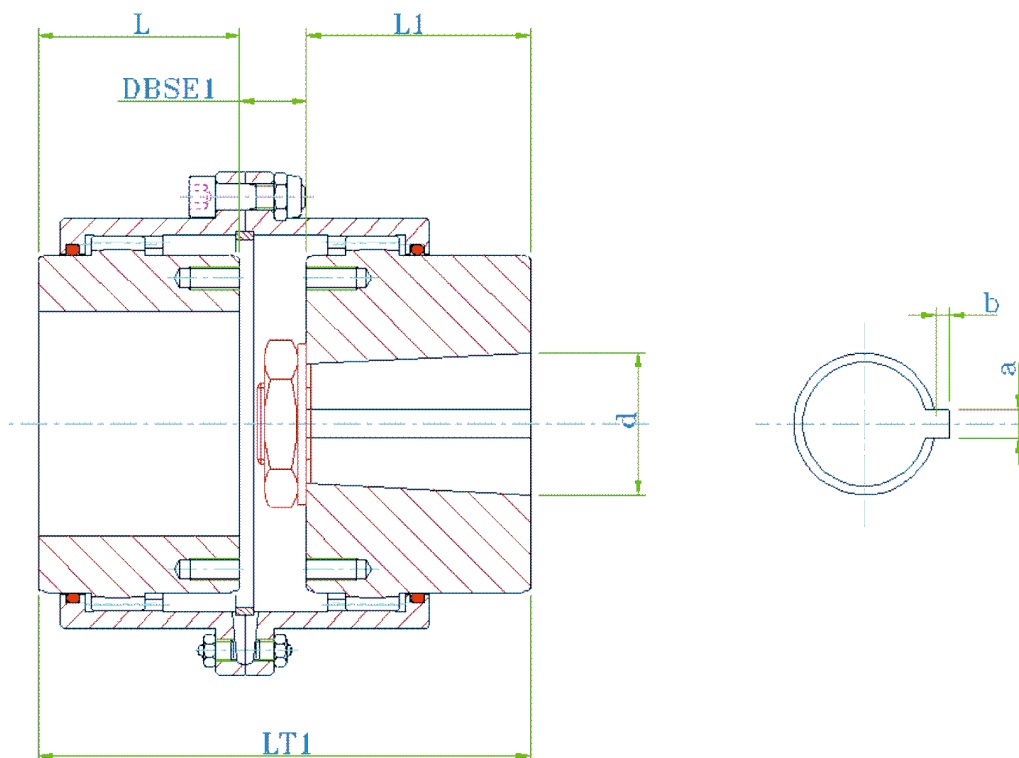
TAGLIA	Tk [kNm]	Tmax [kNm]	VELOCITA' MAX [rpm]	FORO MAX d [mm]	A1 [mm]	B [mm]	L [mm]	LT [mm]	N [mm]	DBSE [mm]
FGC.96.CS	1.9	4.2	6000	52	88	68	43	89	39	3
FGC.122.CS	2.9	6.8	4550	62	108	86	50	103	45.5	3
FGC.148.CS	5.7	14.0	4000	78	133	105	62	127	59	3
FGC.178.CS	9.0	21.5	3900	98	163	132	76	157	68	5
FGC.203.CS	14.5	35.0	3700	112	188	151	90	185	82.5	5
FGC.236.CS	22.8	54.7	3550	132	213	179	105	216	93	6
FGC.270.CS	34.8	83.5	3000	156	248	209	120	246	106	6
FGC.300.CS	45.8	110	2750	174	278	234	135	278	118	8
FGC.335.CS	70.8	170	2420	190	313	255	150	308	138	8
FGC.368.CS	85.4	205	2270	210	338	280	175	358	154	8
FGC.400.CS	150	360	1950	233	368	306	190	388	166	8
FGC.460.CS	200	480	1730	280	423	356	220	450	193	10



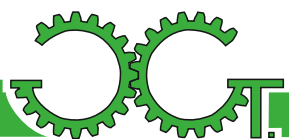


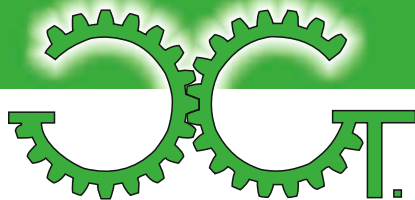
GIUNTI A DENTI PER MOTORI MILL

SERIE FGC.MM



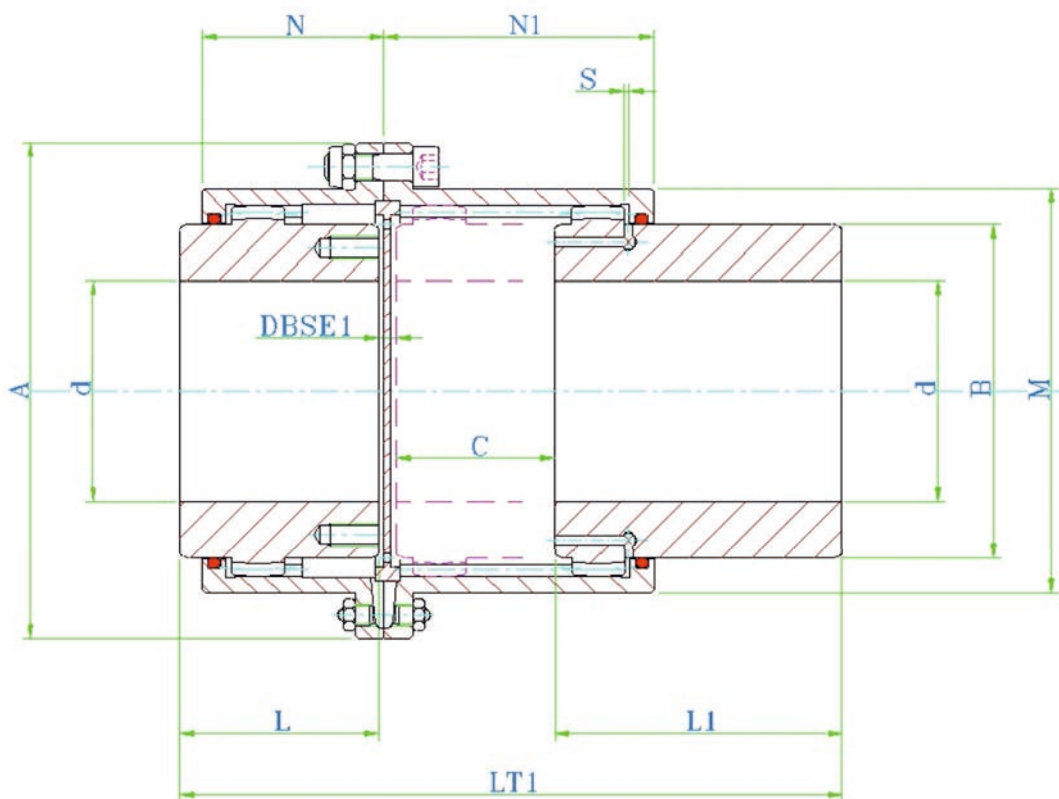
TAGLIA	Tk [kNm]	Tmax [kNm]	VELOCITA' MAX [rpm]	FORO MAX d [mm]	A [mm]	B [mm]	L1 [mm]	LT1 [mm]	M [mm]	N [mm]	DBSE1 [mm]
FGC.96.MM	1.9	4.2	6000	52	111	68	105	151	82.5	39	28
FGC.122.MM	2.9	6.8	4550	62	142	86	115	168	104.6	45.5	30
FGC.148.MM	5.7	14.0	4000	78	168	105	130	195	130.5	59	30
FGC.178.MM	9.0	21.5	3900	98	200	132	150	231	158.4	68	35
FGC.203.MM	14.5	35.0	3700	112	225	151	170	265	183.4	82.5	41
FGC.236.MM	22.8	54.7	3550	132	265	179	185	296	211.5	93	46
FGC.270.MM	34.8	83.5	3000	156	300	209	215	296	245.5	106	52
FGC.300.MM	45.8	110	2750	174	330	234	245	341	275	118	54
FGC.335.MM	70.8	170	2420	190	370	255	295	388	307	138	70
FGC.368.MM	85.4	205	2270	210	406	280	300	453	335	154	70
FGC.400.MM	150	360	1950	233	439	306	305	483	367	166	70



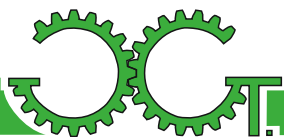


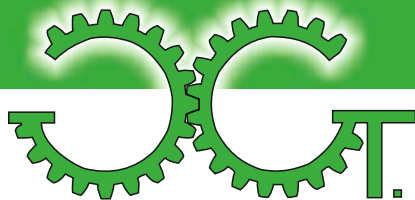
GIUNTI A DENTI SCORREVOLI

SERIE FGC.SG



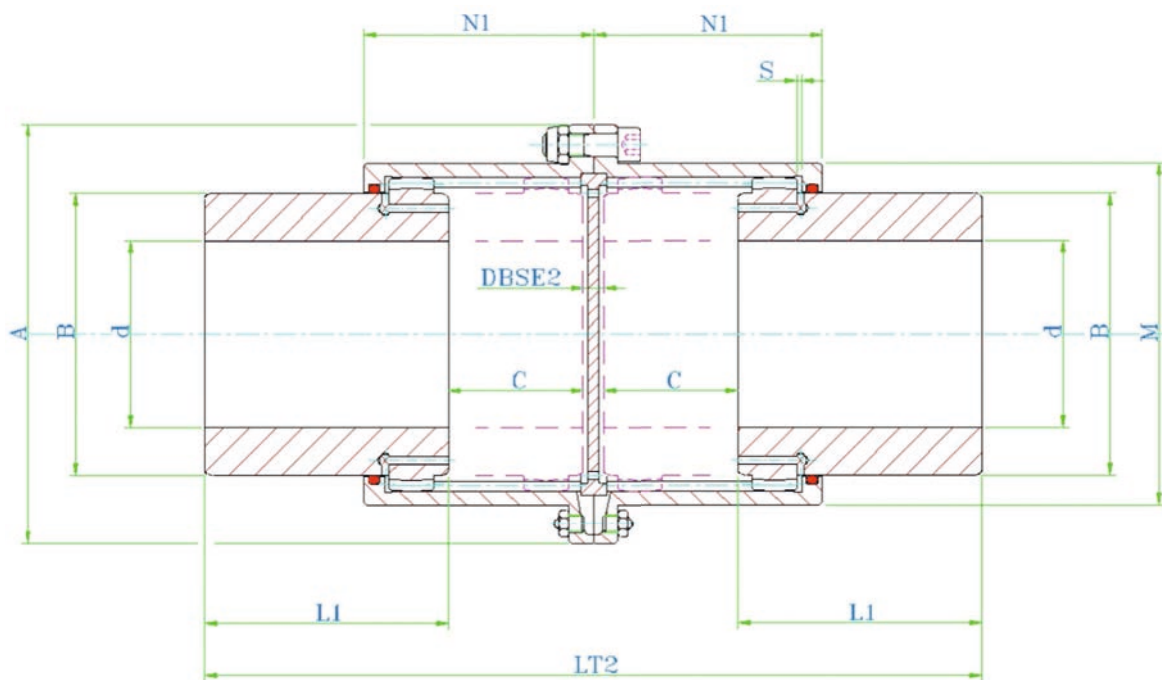
TAGLIA	Tk [kNm]	Tmax [kNm]	VELOCITA' MAX [rpm]	FORO MAX d [mm]	A [mm]	B [mm]	L [mm]	L1 [mm]	N [mm]	LT1 [mm]	N1 [mm]	DBSE1 [mm]	C [mm]
FGC.96.SG	1.9	4.2	6000	52	111	68	43	100	39	212	92	7	62
FGC.122.SG	2.9	6.8	4550	62	142	86	50	102	45.5	221	98	7	62
FGC.148.SG	5.7	14.0	4000	78	168	105	62	110	59	243	106	7	64
FGC.178.SG	9.0	21.5	3900	98	200	132	76	122	68	278	119	8	72
FGC.203.SG	14.5	35.0	3700	112	225	151	90	130	82.5	300	122	8	72
FGC.236.SG	22.8	54.7	3550	132	265	179	105	144	93	339	137	10	80
FGC.270.SG	34.8	83.5	3000	156	300	209	120	156	106	374	151	10	88
FGC.300.SG	45.8	110	2750	174	330	234	135	162	118	399	158	14	88
FGC.335.SG	70.8	170	2420	190	370	255	150	180	138	446	181	14	102
FGC.368.SG	85.4	205	2270	210	406	280	175	220	154	539	213	14	130
FGC.400.SG	150	360	1950	233	439	306	190	220	166	554	217	14	130
FGC.460.SG	200	480	1730	280	505	356	220	210	193	556	209	16	110



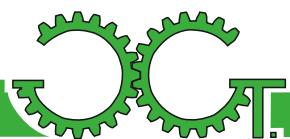


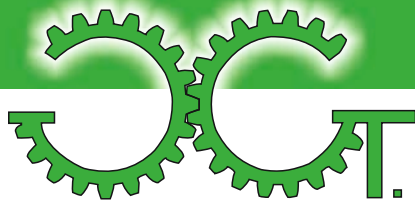
GIUNTI A DENTI A DOPPIO SCORRIMENTO

SERIE FGC.SGG



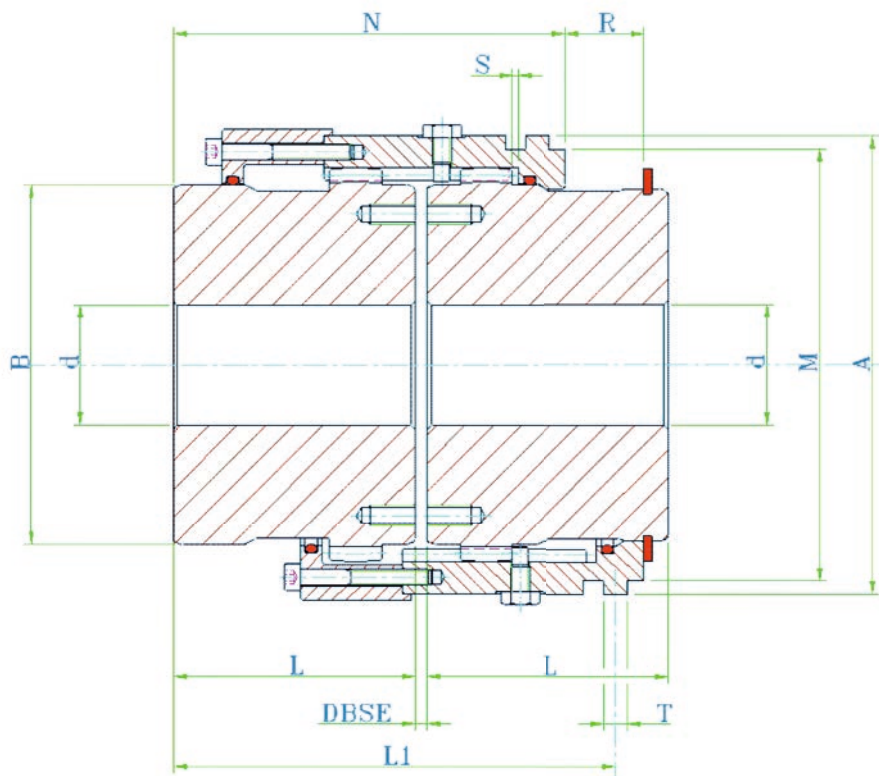
TAGLIA	Tk [kNm]	Tmax [kNm]	VELOCITA' MAX [rpm]	FORO MAX d [mm]	A [mm]	B [mm]	L1 [mm]	N1 [mm]	DBSE2 [mm]	2 X C [mm]
FGC.96.SGG	1.9	4.2	6000	52	111	68	100	92	11	124
FGC.122.SGG	2.9	6.8	4550	62	142	86	102	98	11	124
FGC.148.SGG	5.7	14.0	4000	78	168	105	110	106	11	128
FGC.178.SGG	9.0	21.5	3900	98	200	132	122	119	11	144
FGC.203.SGG	14.5	35.0	3700	112	225	151	130	122	11	144
FGC.236.SGG	22.8	54.7	3550	132	265	179	144	137	14	160
FGC.270.SGG	34.8	83.5	3000	156	300	209	156	151	14	176
FGC.300.SGG	45.8	110	2750	174	330	234	162	158	20	176
FGC.335.SGG	70.8	170	2420	190	370	255	180	181	20	204
FGC.368.SGG	85.4	205	2270	210	406	280	220	213	20	260
FGC.400.SGG	150	360	1950	233	439	306	220	217	20	260
FGC.460.SGG	200	480	1730	280	505	356	210	209	22	220



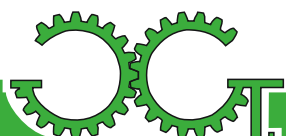


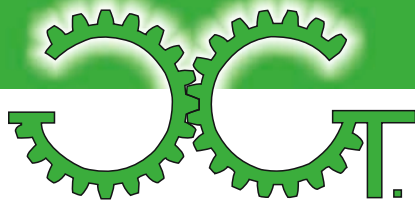
GIUNTI A DENTI DISINNESTABILI

SERIE FGC.DI



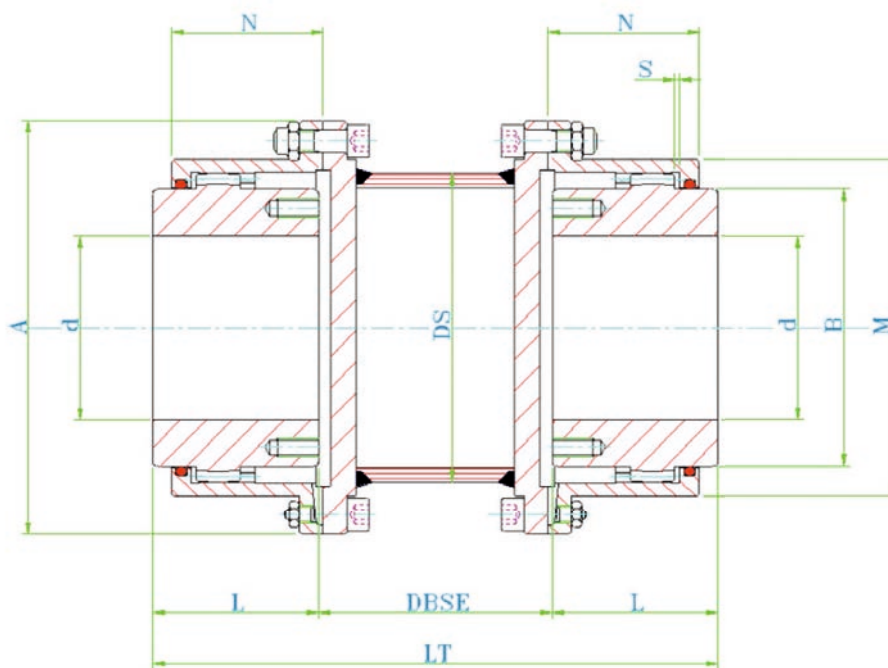
TAGLIA	Tk [kNm]	Tmax [kNm]	VELOCITA' MAX [rpm]	FORO MAX d [mm]	A [mm]	B [mm]	L [mm]	N [mm]	L1 [mm]	DBSE [mm]	T [mm]	M [mm]	R [mm]
FGC.96.DI	1.9	4.55	3000	52	98	68	60	98	112	3	6	90	17
FGC.122.DI	2.9	7	2500	62	118	86	70	111	124	3	6	110	22
FGC.148.DI	5.85	14	2000	78	150	105	85	135.5	152.5	3	8	138	29
FGC.178.DI	9.15	22	1800	98	173	132	95	155.5	176	5	8	161	32
FGC.203.DI	14.8	35.5	1500	112	198	151	105	170.5	192.5	5	8	186	34
FGC.236.DI	23.9	57.4	1350	132	228	179	120	195	220	6	12	215	39
FGC.270.DI	36.5	87.7	1200	156	258	209	130	206	235	6	12	248	45
FGC.300.DI	46.3	111.1	1100	174	288	234	150	238	272	8	12	273	50
FGC.335.DI	73.5	176.3	950	190	318	255	175	279	319	8	12	300	56
FGC.368.DI	88.2	211.7	900	210	348	280	190	303	348	8	12	329	62
FGC.400.DI	160	384	800	233	393	306	220	356	407	8	12	374	70
FGC.460.DI	213.5	513	700	280	448	356	250	404	461	10	16	356	77



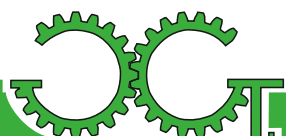


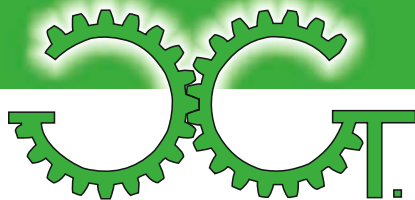
GIUNTI A DENTI CON SPAZIATORE TUBOLARE

SERIE FGC.T



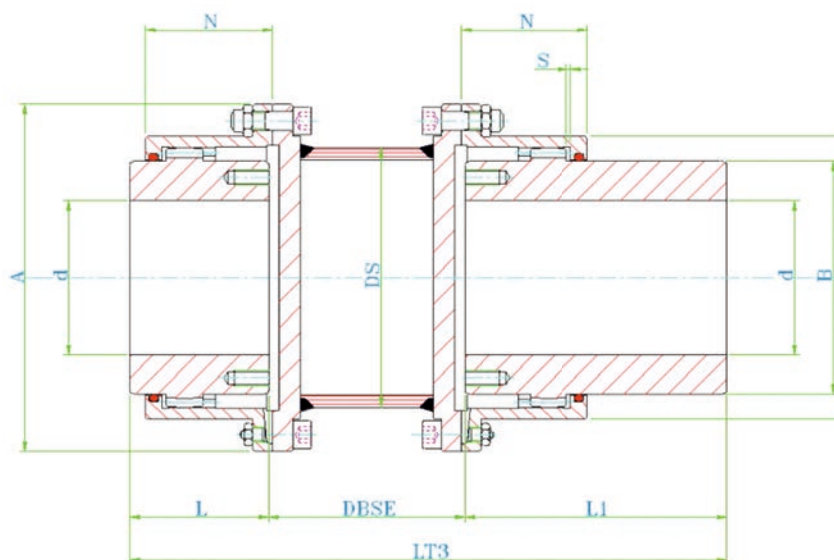
TAGLIA	Tk [kNm]	Tmax [kNm]	VELOCITA' MAX [rpm]	FORO MAX d [mm]	A [mm]	B [mm]	L [mm]	L1 [mm]	M [mm]	N [mm]	DS [mm]
FGC.96.T	1.9	4.2	6000	52	111	68	43	105	82.5	39	82.5
FGC.122.T	2.9	6.8	4550	62	142	86	50	115	104.6	45.5	88.9
FGC.148.T	5.7	14.0	4000	78	168	105	62	130	130.5	59	127
FGC.178.T	9.0	21.5	3900	98	200	132	76	150	158.4	68	139
FGC.203.T	14.5	35.0	3700	112	225	151	90	170	183.4	82.5	168
FGC.236.T	22.8	54.7	3550	132	265	179	105	185	211.5	93	168
FGC.270.T	34.8	83.5	3000	156	300	209	120	215	245.5	106	219
FGC.300.T	45.8	110	2750	174	330	234	135	245	275	118	273
FGC.335.T	70.8	170	2420	190	370	255	150	295	307	138	273
FGC.368.T	85.4	205	2270	210	406	280	175	300	335	154	324
FGC.400.T	150	360	1950	233	439	306	190	305	367	166	355
FGC.460.T	200	480	1730	280	505	356	220	310	423	193	406





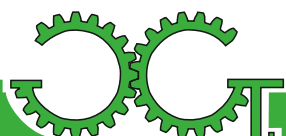
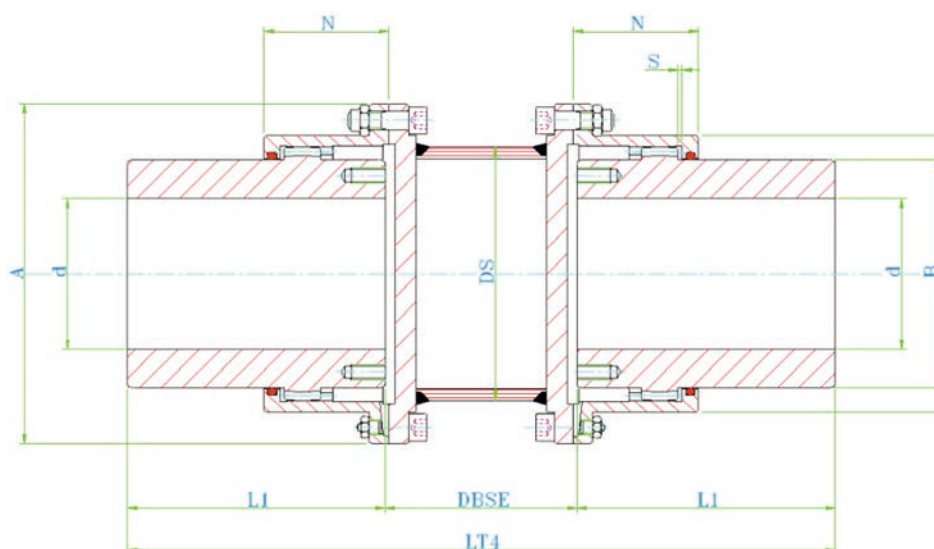
**GIUNTI A DENTI CON SPAZIATORE
TUBOLARE E UN MOZZO PROLUNGATO**

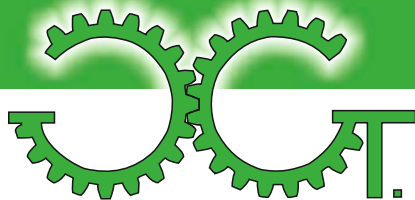
SERIE FGC.TL



**GIUNTI A DENTI CON SPAZIATORE
TUBOLARE E MOZZI PROLUNGATI**

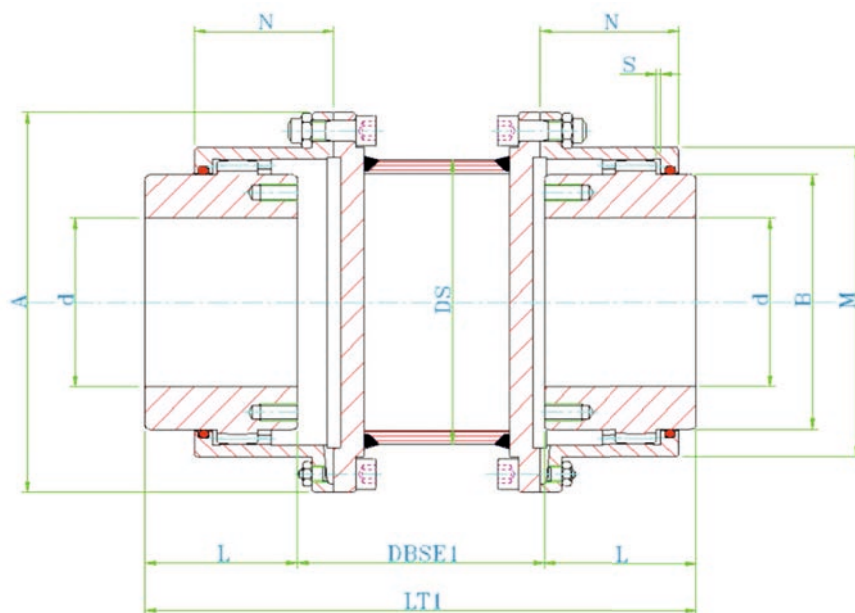
SERIE FGC.TLL





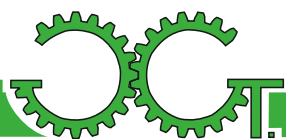
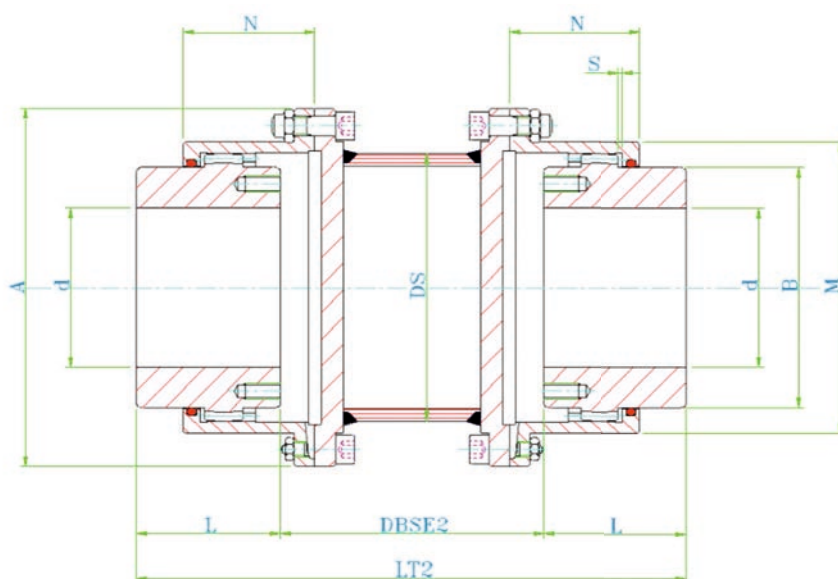
**GIUNTI A DENTI CON SPAZIATORE
TUBOLARE E UN MOZZO INVERTITO**

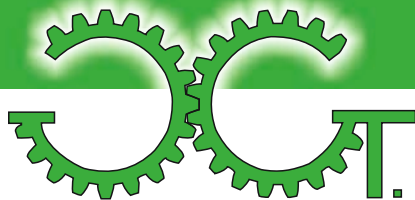
SERIE FGC.TR



**GIUNTI A DENTI CON SPAZIATORE
TUBOLARE E MOZZI INVERTITI**

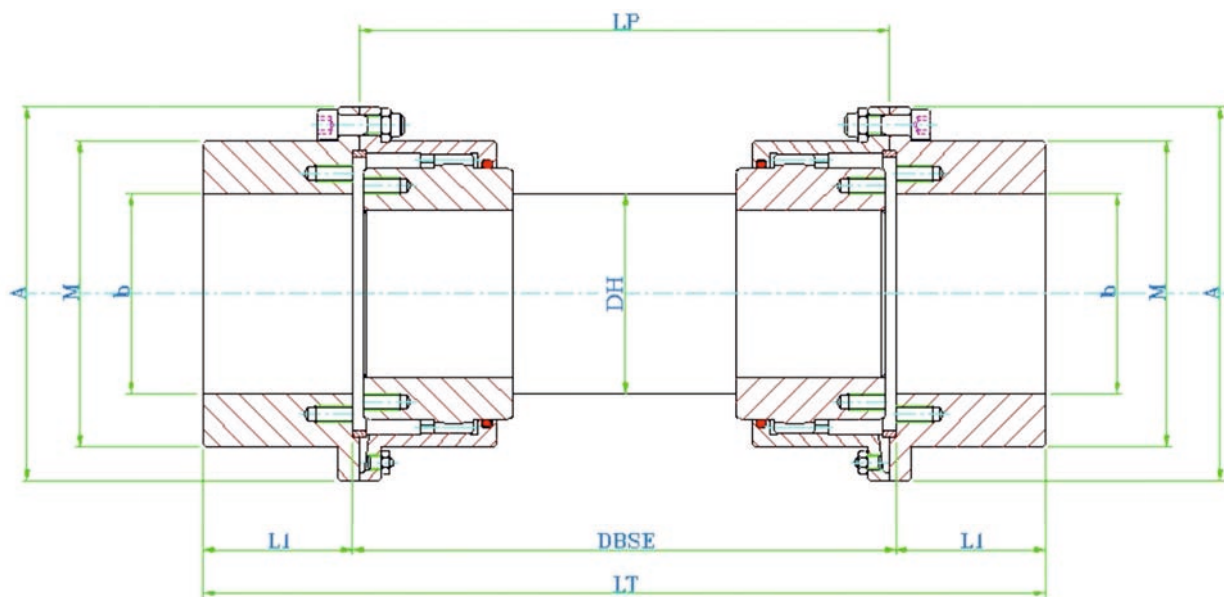
SERIE FGC.TRR



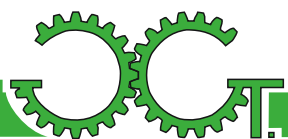


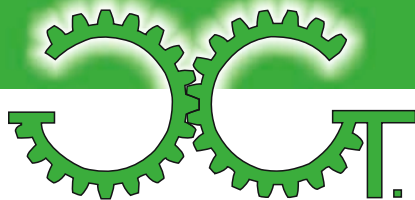
GIUNTI A DENTI CON ALBERO FLOTTANTE INTERMEDIO

SERIE FGC.S



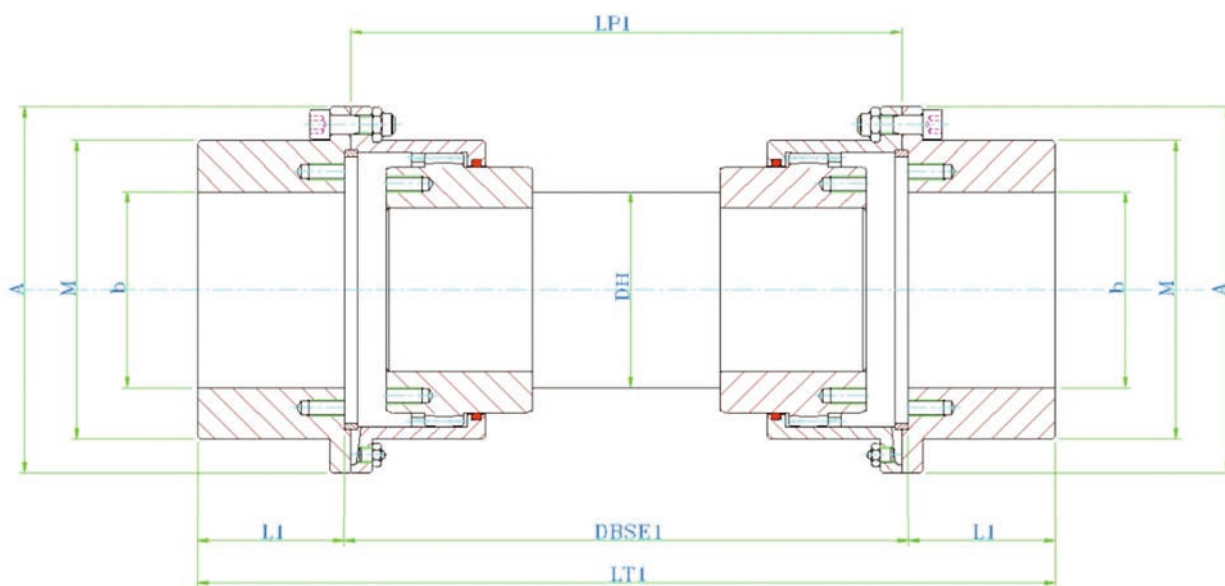
TAGLIA	Tk [kNm]	Tmax [kNm]	VELOCITA' MAX [rpm]	FORO MAX d [mm]	A [mm]	B [mm]	L1 [mm]	M [mm]	N [mm]	DH [mm]
FGC.96.S	1.9	4.2	6000	52	111	68	43	82.5	63	55
FGC.122.S	2.9	6.8	4550	62	142	86	50	104.6	74	65
FGC.148.S	5.7	14.0	4000	78	168	105	62	130.5	89	80
FGC.178.S	9.0	21.5	3900	98	200	132	76	158.4	102	100
FGC.203.S	14.5	35.0	3700	112	225	151	90	183.4	108	115
FGC.236.S	22.8	54.7	3550	132	265	179	105	211.5	118	135
FGC.270.S	34.8	83.5	3000	156	300	209	120	245.5	130	160
FGC.300.S	45.8	110	2750	174	330	234	135	275	138	180
FGC.335.S	70.8	170	2420	190	370	255	150	307	156	195
FGC.368.S	85.4	205	2270	210	406	280	175	335	152	215
FGC.400.S	150	360	1950	233	439	306	190	367	160	235
FGC.460.S	200	480	1730	280	505	356	220	423	180	285



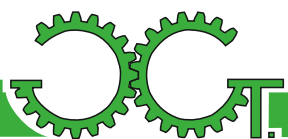


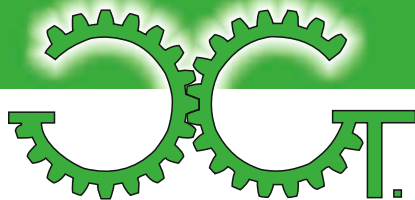
GIUNTI A DENTI CON ALBERO FLOTTANTE INTERMEDIO E MOZZI INVERTITI

SERIE FGC.SR



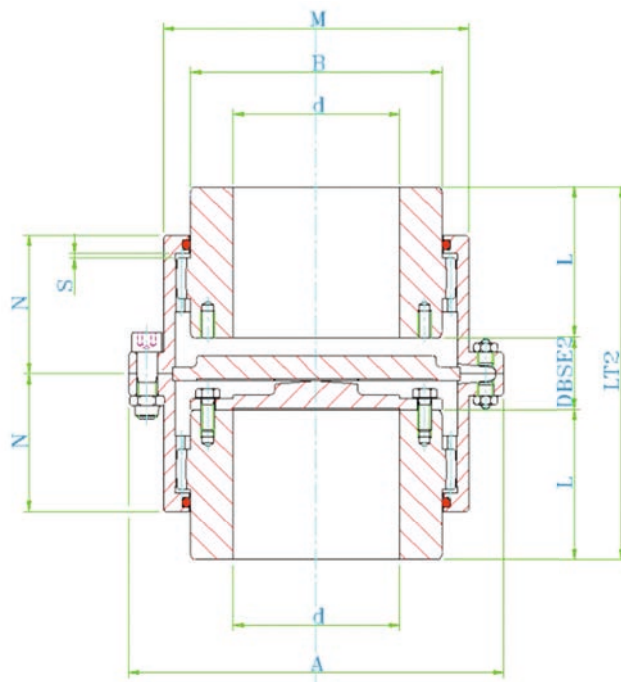
TAGLIA	Tk [kNm]	Tmax [kNm]	VELOCITA' MAX [rpm]	FORO MAX d [mm]	A [mm]	B [mm]	L1 [mm]	M [mm]	DH [mm]
FGC.96.SR	1.9	4.2	6000	52	111	68	43	82.5	55
FGC.122.SR	2.9	6.8	4550	62	142	86	50	104.6	65
FGC.148.SR	5.7	14.0	4000	78	168	105	62	130.5	80
FGC.178.SR	9.0	21.5	3900	98	200	132	76	158.4	100
FGC.203.SR	14.5	35.0	3700	112	225	151	90	183.4	115
FGC.236.SR	22.8	54.7	3550	132	265	179	105	211.5	135
FGC.270.SR	34.8	83.5	3000	156	300	209	120	245.5	160
FGC.300.SR	45.8	110	2750	174	330	234	135	275	180
FGC.335.SR	70.8	170	2420	190	370	255	150	307	195
FGC.368.SR	85.4	205	2270	210	406	280	175	335	215
FGC.400.SR	150	360	1950	233	439	306	190	367	235
FGC.460.SR	200	480	1730	280	505	356	220	423	285



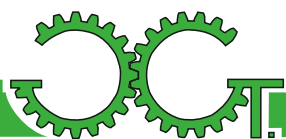


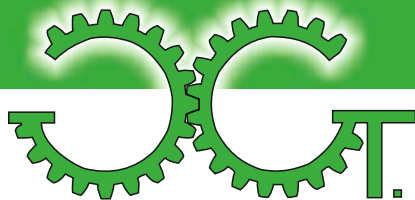
GIUNTI A DENTI PER MONTAGGIO VERTICALE

SERIE FGC.V



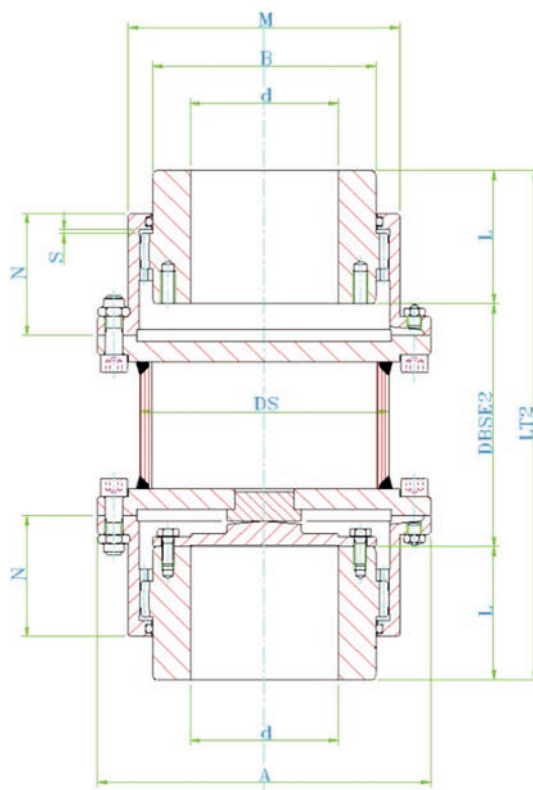
TAGLIA	Tk [kNm]	Tmax [kNm]	VELOCITA' MAX [rpm]	FORO MAX d [mm]	A [mm]	B [mm]	L [mm]	LT2 [mm]	M [mm]	N [mm]	DBSE2 [mm]
FGC.96.V	1.9	4.2	6000	52	111	68	43	109	82.5	39	23
FGC.122.V	2.9	6.8	4550	62	142	86	50	123	104.6	45.5	23
FGC.148.V	5.7	14.0	4000	78	168	105	62	155	130.5	59	31
FGC.178.V	9.0	21.5	3900	98	200	132	76	183	158.4	68	31
FGC.203.V	14.5	35.0	3700	112	225	151	90	223	183.4	82.5	43
FGC.236.V	22.8	54.7	3550	132	265	179	105	258	211.5	93	48
FGC.270.V	34.8	83.5	3000	156	300	209	120	298	245.5	106	58
FGC.300.V	45.8	110	2750	174	330	234	135	336	275	118	66
FGC.335.V	70.8	170	2420	190	370	255	150	392	307	138	92
FGC.368.V	85.4	205	2270	210	406	280	175	448	335	154	98
FGC.400.V	150	360	1950	233	439	306	190	488	367	166	108
FGC.460.V	200	480	1730	280	505	356	220	450	423	193	134



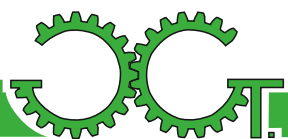


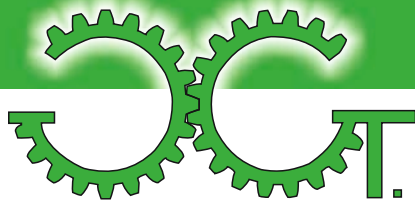
GIUNTI A DENTI CON SPAZIATORE TUBOLARE PER MONTAGGIO VERTICALE

SERIE FGC.TV

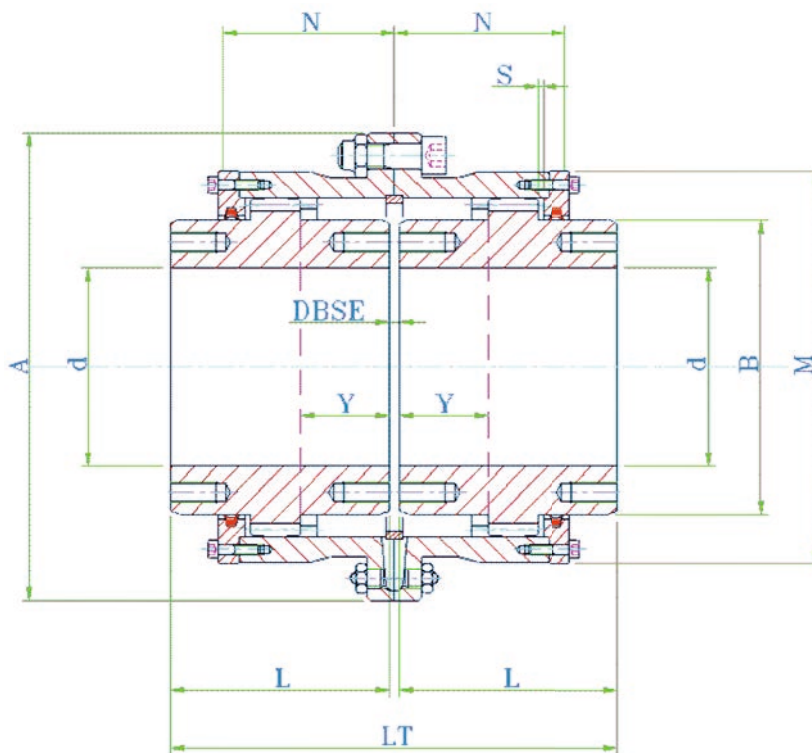


TAGLIA	Tk [kNm]	Tmax [kNm]	VELOCITA' MAX [rpm]	FORO MAX d [mm]	A [mm]	B [mm]	L [mm]	M [mm]	N [mm]
FGC.96.TV	1.9	4.2	6000	52	111	68	43	82.5	39
FGC.122.TV	2.9	6.8	4550	62	142	86	50	104.6	45.5
FGC.148.TV	5.7	14.0	4000	78	168	105	62	130.5	59
FGC.178.TV	9.0	21.5	3900	98	200	132	76	158.4	68
FGC.203.TV	14.5	35.0	3700	112	225	151	90	183.4	82.5
FGC.236.TV	22.8	54.7	3550	132	265	179	105	211.5	93
FGC.270.TV	34.8	83.5	3000	156	300	209	120	245.5	106
FGC.300.TV	45.8	110	2750	174	330	234	135	275	118
FGC.335.TV	70.8	170	2420	190	370	255	150	307	138
FGC.368.TV	85.4	205	2270	210	406	280	175	335	154
FGC.400.TV	150	360	1950	233	439	306	190	367	166
FGC.460.TV	200	480	1730	280	505	356	220	423	193



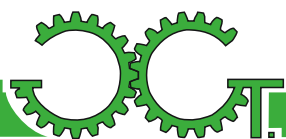


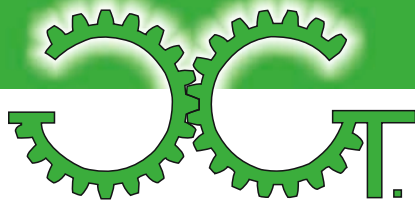
GIUNTI A DENTI IN ACCIAIO INOSSIDABILE SERIE FGC.SS



TAGLIA	Tk [kNm]	Tmax [kNm]	VELOCITA' MAX [rpm]	FORO MAX d [mm]	A [mm]	B [mm]	L [mm]	LT [mm]	M [mm]	N [mm]	DBSE [mm]
FGC.96.SS	3.6	7.2	6000	52	111	68	43	89	82.5	39	3
FGC.122.SS	5.6	11.2	4550	62	142	86	50	103	104.6	45.5	3
FGC.148.SS	11	22	4000	78	168	105	62	127	130.5	59	3
FGC.178.SS	18	36	3900	98	200	132	76	157	158.4	68	5
FGC.203.SS	27	54	3700	112	225	151	90	185	183.4	82.5	5
FGC.236.SS	43	86	3550	132	265	179	105	216	211.5	93	6
FGC.270.SS	74	148	3000	156	300	209	120	246	245.5	106	6
FGC.300.SS	109	218	2750	174	330	234	135	278	275	118	8
FGC.335.SS	133	266	2420	190	370	255	150	308	307	138	8
FGC.368.SS	215	430	2270	210	406	280	175	358	335	154	8
FGC.400.SS	265	530	1950	233	439	306	190	388	367	166	8
FGC.460.SS	330	660	1730	280	505	356	220	450	423	193	10

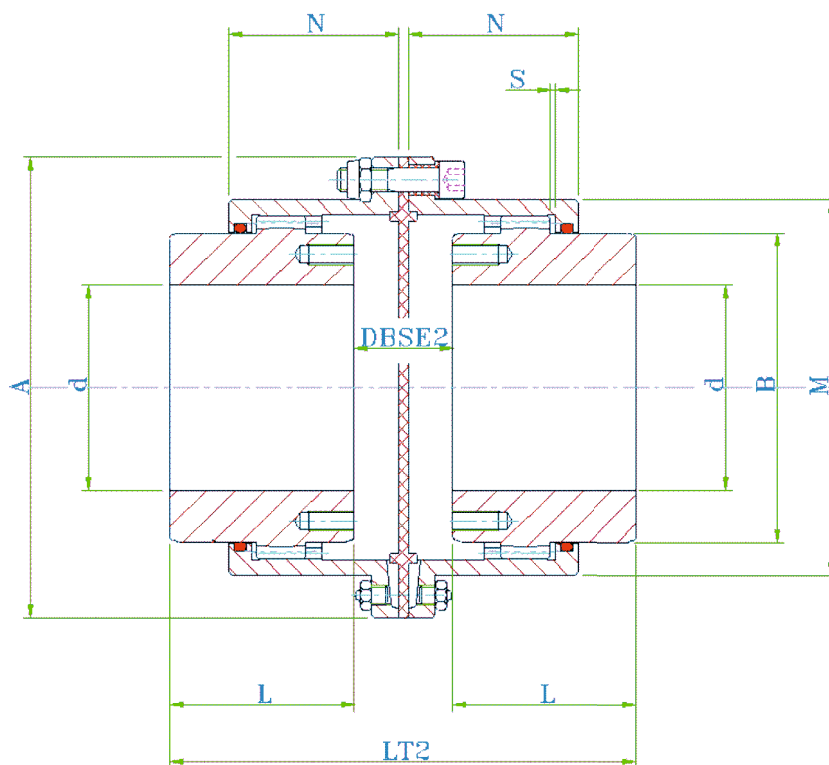
S = DBSE/2





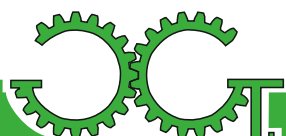
GIUNTI A DENTI CON ISOLAMENTO ELETTRICO

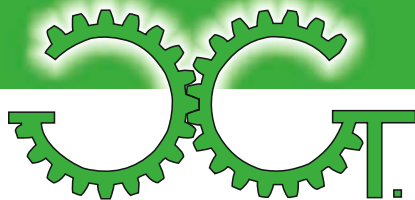
SERIE FGC.EI



TAGLIA	Tk [kNm]	Tmax [kNm]	VELOCITA' MAX [rpm]	FORO MAX d [mm]	A [mm]	B [mm]	L [mm]	LT [mm]	M [mm]	N [mm]	DBSE2 [mm]
FGC.96.EI	1.9	4.2	6000	52	111	68	43	93	82.5	39	10
FGC.122.EI	2.9	6.8	4550	62	142	86	50	113	104.6	45.5	16
FGC.148.EI	5.7	14.0	4000	78	168	105	62	149	130.5	59	28
FGC.178.EI	9.0	21.5	3900	98	200	132	76	190	158.4	68	42
FGC.203.EI	14.5	35.0	3700	112	225	151	90	223	183.4	82.5	47
FGC.236.EI	22.8	54.7	3550	132	265	179	105	258	211.5	93	52
FGC.270.EI	34.8	83.5	3000	156	300	209	120	298	245.5	106	63
FGC.300.EI	45.8	110	2750	174	330	234	135	336	275	118	71
FGC.335.EI	70.8	170	2420	190	370	255	150	392	307	138	97
FGC.368.EI	85.4	205	2270	210	406	280	175	448	335	154	103
FGC.400.EI	150	360	1950	233	439	306	190	488	367	166	113
FGC.460.EI	200	480	1730	280	505	356	220	574	423	193	139

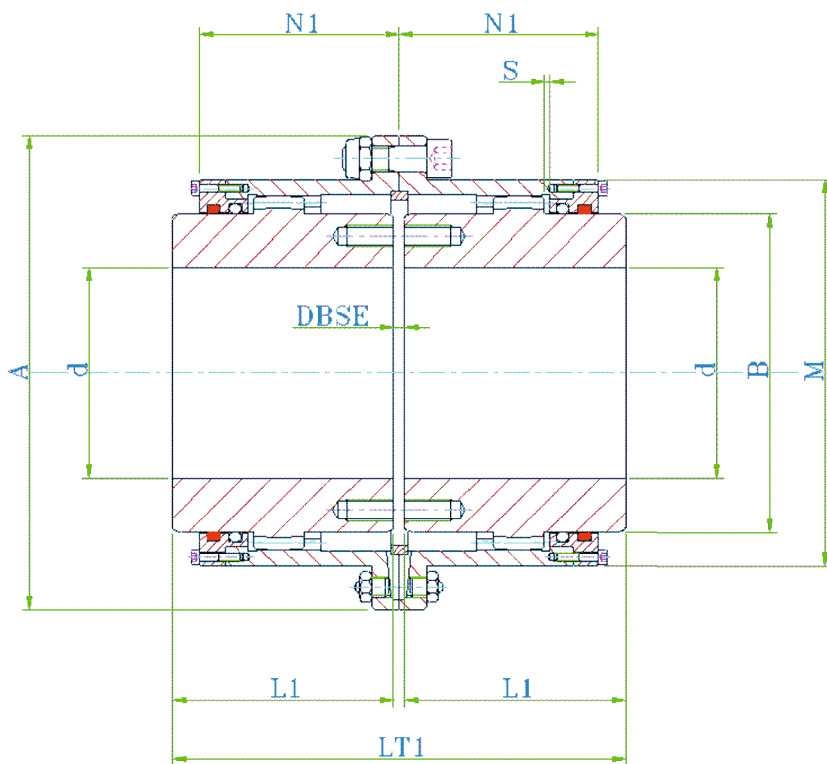
S = DBSE/2





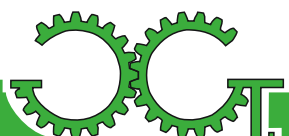
GIUNTI A DENTI CON GUARNIZIONI IN FELTRO

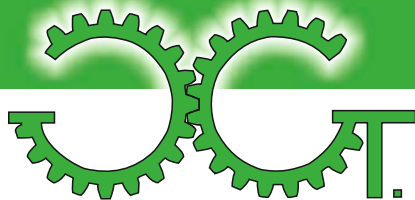
SERIE FGC.FE



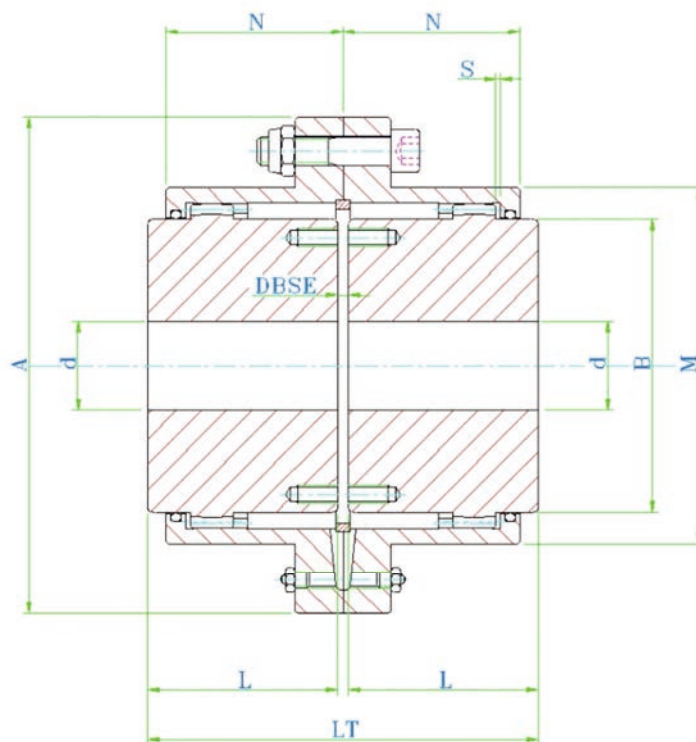
TAGLIA	Tk [kNm]	Tmax [kNm]	VELOCITA' MAX [rpm]	FORO MAX d [mm]	A [mm]	B [mm]	L1 [mm]	LT1 [mm]	M [mm]	DBSE [mm]
FGC.96.FE	1.9	4.2	6000	52	111	68	105	213	82.5	3
FGC.122.FE	2.9	6.8	4550	62	142	86	115	233	104.6	3
FGC.148.FE	5.7	14.0	4000	78	168	105	130	263	130.5	3
FGC.178.FE	9.0	21.5	3900	98	200	132	150	305	158.4	5
FGC.203.FE	14.5	35.0	3700	112	225	151	170	345	183.4	5
FGC.236.FE	22.8	54.7	3550	132	265	179	185	376	211.5	6
FGC.270.FE	34.8	83.5	3000	156	300	209	215	436	245.5	6
FGC.300.FE	45.8	110	2750	174	330	234	245	498	275	8
FGC.335.FE	70.8	170	2420	190	370	255	295	598	307	8
FGC.368.FE	85.4	205	2270	210	406	280	300	608	335	8
FGC.400.FE	150	360	1950	233	439	306	305	618	367	8
FGC.460.FE	200	480	1730	280	505	356	310	630	423	10

S = DBSE/2



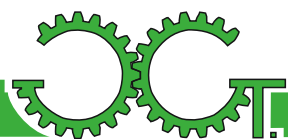


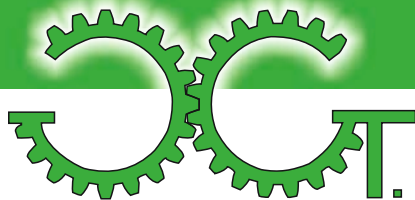
GIUNTI A DENTI SERIE AGMA



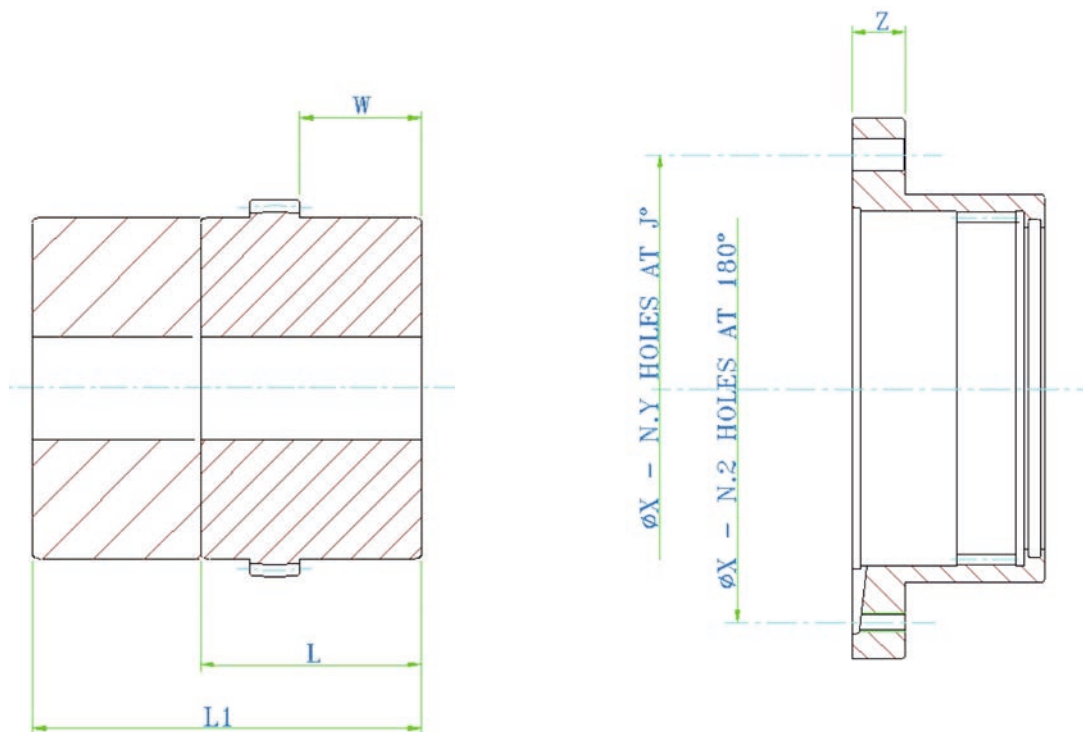
TAGLIA	INTERASSE FORATURA "X"	BULLONI		SPESSORE FLANGIA Z	LUNGHEZZA MOZZO L	MOZZO PROLUNGATO L1	W
		Q.ta'	Tipo				
A 1	3.750	6	1/4	0.52	1.69	4.00	0.75
A 1.5	4.812	8	3/8	0.76	1.94	4.50	0.81
A 2	5.875	6	1/2	0.76	2.44	4.50	1.25
A 2.5	7.125	6	5/8	0.85	3.03	6.50	1.53
A 3	8.125	8	5/8	0.85	3.59	7.00	1.69
A 3.5	9.500	8	3/4	1.06	4.19	7.50	1.88
A 4	11.000	8	3/4	1.06	4.75	8.25	2.16
A 4.5	12.000	10	3/4	1.06	5.31	9.00	2.56
A 5	13.500	8	7/8	1.45	6.03	9.50	2.94
A 5.5	14.500	14	7/8	1.45	6.91	10.50	3.19
A 6	15.750	14	7/8	1.00	7.41	SU RICHIESTA	
A 7	18.250	16	1	1.12	8.69		

$$S = DBSE/2 \quad L = (LT - DBSE)/2$$

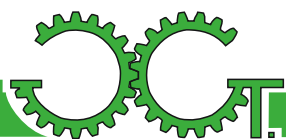


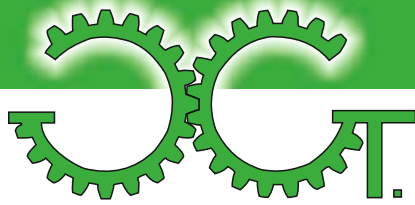


GIUNTI A DENTI SERIE AGMA DETTAGLIO COMPONENTI: MOZZI E CAMPANE



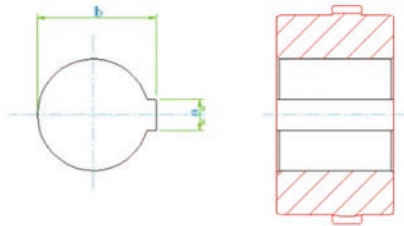
TAGLIA	INTERASSE FORATURA "X"	BULLONI		SPESSORE FLANGIA Z	LUNGHEZZA MOZZO L	MOZZO PROLUNGATO L1	W
		Q.ta '	Tipo				
A 1	3.750	6	1/4	0.52	1.69	4.00	0.75
A 1.5	4.812	8	3/8	0.76	1.94	4.50	0.81
A 2	5.875	6	1/2	0.76	2.44	4.50	1.25
A 2.5	7.125	6	5/8	0.85	3.03	6.50	1.53
A 3	8.125	8	5/8	0.85	3.59	7.00	1.69
A 3.5	9.500	8	3/4	1.06	4.19	7.50	1.88
A 4	11.000	8	3/4	1.06	4.75	8.25	2.16
A 4.5	12.000	10	3/4	1.06	5.31	9.00	2.56
A 5	13.500	8	7/8	1.45	6.03	9.50	2.94
A 5.5	14.500	14	7/8	1.45	6.91	10.50	3.19
A 6	15.750	14	7/8	1.00	7.41	SU RICHIESTA	
A 7	18.250	16	1	1.12	8.69		



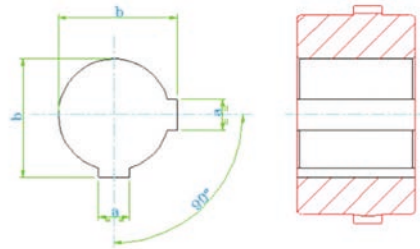


TIPOLOGIE DI FORO FINITO

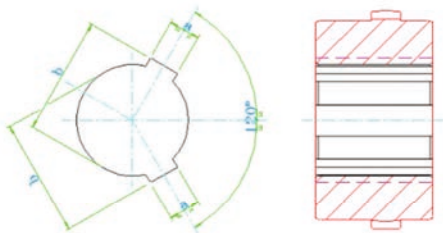
FORO FINITO
CILINDRICO E 1 CAVA



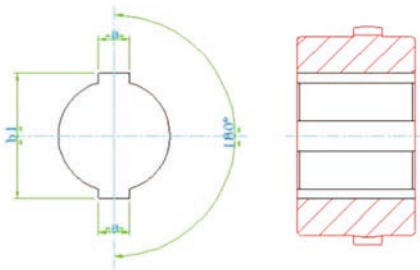
FORO FINITO
CILINDRICO E 2 CAVE @ 90°



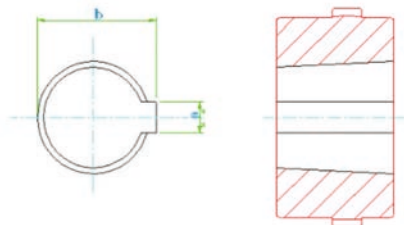
FORO FINITO
CILINDRICO E 2 CAVE @ 120°



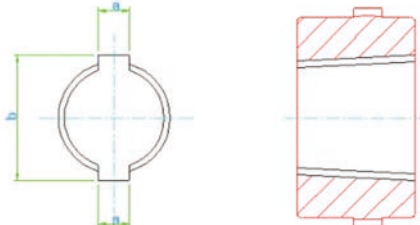
FORO FINITO
CILINDRICO A 2 CAVE @ 180°



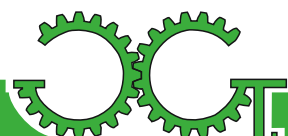
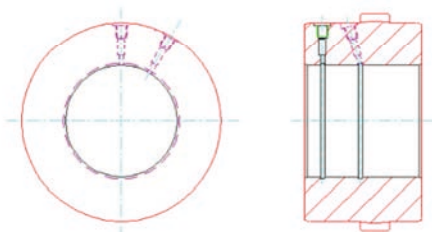
FORO FINITO
CONICO E 1 CAVA

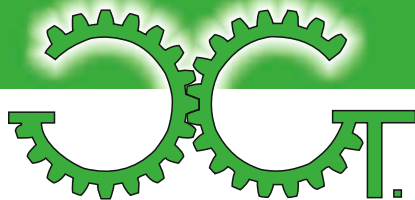


FORO FINITO
CONICO E 2 CAVE @ 180°



FORO FINITO CILINDRICO
PREDISPOSTO PER MONTAGGIO A CALDO
E SMONTAGGIO A PRESSIONE D'OLIO





INSTALLAZIONE, MANUTENZIONE & LUBRIFICAZIONE

Istruzione per l'istallazione:

- 1) Smontare il giunto nei suoi componenti principali mozzi e campane.
- 2) Assicurarsi che tutti i componenti siano puliti.
- 3) Inserire le campane o le flange porta guarnizioni sugli alberi.
- 4) Eseguire il calettamento dei mozzi sugli alberi, se si procede al riscaldamento dei mozzi, non superare mai la temperatura di 170°C.
- 5) Per garantire una durata ottimale del giunto è necessario eseguire l'allineamento degli alberi in modo scrupoloso, come indicato di seguito. Per eseguire l'allineamento utilizzare un comparatore fisso su uno dei due mozzi e farlo ruotare sull'altro mozzo (fig. 8): la lettura del valore diviso per due dà il valore del disallineamento parallelo. Il disallineamento angolare va controllato con un comparatore fissato su un mozzo e fatto ruotare sulla facciata dell'altro mozzo (fig. 8), oppure controllato con spessimetro in almeno tre posizioni a 120°C (fig. 9). Nel caso di istallazione di giunti completi di allunghe, eseguire l'allineamento mediante laser; se non fosse possibile l'utilizzo del laser, seguire le istruzioni secondo la figura 10.
- 6) Eseguito l'allineamento degli alberi, procedere alla lubrificazione delle guarnizioni e al montaggio delle campane sui mozzi.
- 7) Unire le due campane mediante le apposite viti fornite con il giunto e serrarle alle coppie riportate in figura 11.

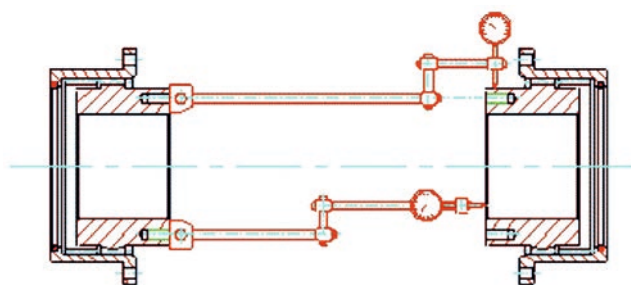


Fig.8

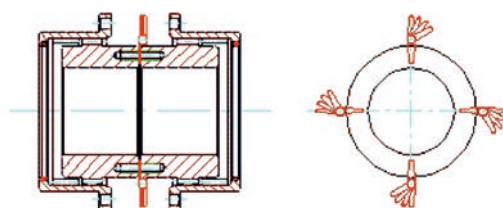


Fig.9

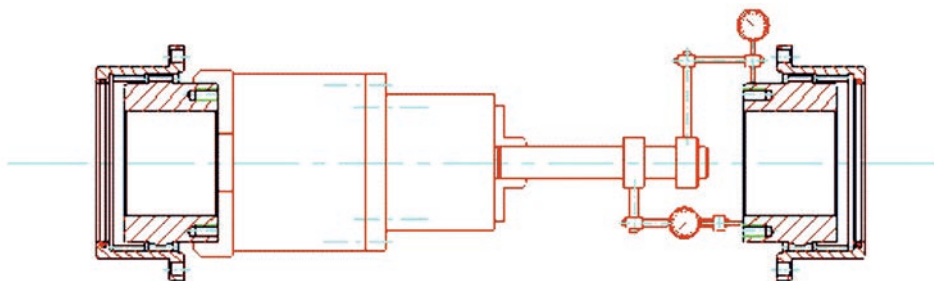
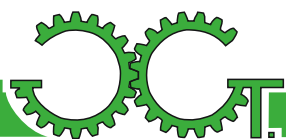
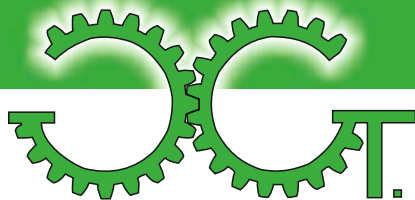


Fig.10





TAGLIA	Coppia di serraggio [Nm]	Interasse fori della flangia [mm]	Numero viti	Foro flangia H8-d8
FGC.96	18	96	6	8/M8
FGC.122	36	122	8	10/M10
FGC.148	36	148	10	10/M10
FGC.178	65	178	10	12/M12
FGC.203	65	203	12	12/M12
FGC.236	150	236	12	16/M16
FGC.270	150	270	14	16/M16
FGC.300	150	300	14	16/M16
FGC.335	220	335	14	18/M18
FGC.368	400	368	14	22/M22
FGC.400	400	400	14	22/M22
FGC.460	520	460	16	24/M24

Fig.11

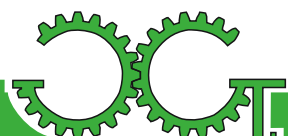
8) Per ottenere un adeguata durata del giunto, la lubrificazione corretta è un passaggio fondamentale; inserire il grasso nel giunto tramite gli ingrassatori posti sulle campane fino al totale riempimento dello stesso, pompando dal foro inferiore finché non si noterà la fuoriuscita del grasso dal foro superiore. Nei periodi immediatamente dopo la prima installazione, eseguire la lubrificazione ogni due mesi, in seguito ogni quattro mesi. Ogni 10.000 ore o due anni di lavoro, eseguire la totale sostituzione del grasso.

I giunti GGT vengono forniti non lubrificati.

Se il giunto è equipaggiato da allunga autolubrificante è necessario eseguire il riempimento solo una volta l'anno, la stessa provvederà a distribuirlo in modo automatico e uniforme al giunto.

Il lubrificante più adatto per il buon funzionamento del giunto a denti GGT rispetta le caratteristiche indicate nella seguente tabella:

Addensante:	Litio complesso
Grado NLGI:	2
Campo d'impiego della temperatura:	- 30°C + 160°C
Penetrazione a 25°C:	265 - 295 (0.1 mm)
Prestazione antiruggine:	YES
Punto di goccia:	> 260°C
Viscosità olio base a 40°C:	340 mm ² /s (cSt)



MINETTI S.P.A.

BERGAMO - Via Canovine, 14
Tel. 035.327111 - Fax 035.314307
www.minettigroup.com
info@minettigroup.com

Filiale **BERGAMO**

BERGAMO - Via Canovine, 14
Tel. 035.327111 - Fax 035.316767

Filiale **BRESCIA**

BRESCIA - Via Di Vittorio, 38
Tel. 030.3582734 - Fax 030.3582760

Filiale **VICENZA**

CREAZZO (VI) - Via F. Filzi, 97
Tel. 0444.521313 - Fax 0444.521671

Filiale **VENEZIA**

MARGHERA (VE) - Via Pinton, 4
Tel. 041.930511 - Fax 041.930616

Filiale **TREVISO**

VILLORBA (TV) - Via Pacinotti, 20
Tel. 0422.919808 - Fax 0422.919928

Filiale **UDINE**

PRADAMANO (UD) - Via Nazionale, 92
Tel. 0432.640098 - Fax 0432.640403

STOCCHI S.R.L.

BERGAMO - Via Cavalieri di Vittorio Veneto, 20
Tel. 035.3693411 - Fax 035.3693428

TRE-VI S.R.L.

TREVIGLIO (BG) - Via Roggia Vailata
Tel. 0363.343332 - Fax 0363.419595

BRUNABOSI S.R.L.

PARMA - Via Cerati, 1/a
Tel. 0521.984346 - Fax 0521.980803

Filiale **Reggio Emilia**

REGGIO EMILIA - Via Bruschi, 23 c/d/e
Tel. 0522.302066 - Fax 0522.302463

INDUSTRIALTECNICA S.P.A.

CALDERARA DI RENO (BO) - Via Roma, 118/H
Tel. 051.3173011 - Fax 051.3173020

Filiale **Cesena**

CESENA - Loc. Pievesestina - Via Fossalta, 3260
Tel. 0547.313286 - Fax 0547.415799

FIMU S.R.L.

ALBA (CN) - Viale Artigianato
Tel. 0173.363731 - Fax 0173.362944

Filiale **Savigliano**

SAVIGLIANO (CN) - Z. Ind. Borgo Marene
Via Artigianato, 14
Tel. 0172.713542 - Fax 0172.715489

Filiale **Torino**

TORINO - Via Farinelli, 6
Tel. 011.3910571 - Fax 011.3486180

FIMU VIGEVANO S.R.L.

VIGEVANO (PV) - Via Rebuffi, 33
Tel. 0381.348280 - Fax 0381.348113

SAROK DUE S.R.L.

S. VITTORE OLONA (MI) - Via I° Maggio, 9/11
Tel. 0331.423911 - Fax 0331.423942

SAROK ITALIA S.P.A.

LECCO - Via Valsugana, 4
Tel. 0341.357811 r.a. - Fax 0341.283096

ZANETTI UTENSILI S.R.L.

BRESCIA - Via G.di Vittorio, 38
Tel. 030.7255535 - Fax 030.7751167



SAROK ITALIA
Lecco

SAROK DUE
S.Vittore O. (MI)

MINETTI S.p.A.
Sede Bergamo

MINETTI
Filiale Bergamo

MINETTI
Filiale Brescia

MINETTI
Filiale Vicenza

MINETTI
Filiale Treviso

MINETTI
Filiale Udine

MINETTI
Filiale Marghera

STOCCHI
Bergamo

ZANETTI UTENSILI
Brescia

TRE-VI
Treviglio (BG)

BRUNABOSI
Sede Parma

BRUNABOSI
Filiale Reggio E.

INDUSTRIALTECNICA
Sede Bologna

INDUSTRIALTECNICA
Filiale Cesena

FIMU
Filiale Torino

FIMU VIGEVANO
Vigevano (PV)

FIMU
Sede Alba (CN)

FIMU
Filiale Savigliano (CN)

Love/ADV.it

MINETTI
SOLUZIONI TECNOLOGICHE



FORNITURE INDUSTRIALI

www.minettigroup.com

UTENSILERIE MECCANICHE